



Istituto di Ricerche sulla Popolazione
e le Politiche Sociali - CNR

IRPPS Working Papers

ISSN 2240-7332

Comparative Delphi report. Summary policy implications of Delphi study

What is IRPPS?

IRPPS is an Interdisciplinary Research Institute that conducts studies on demographic and migration issues, welfare systems and social policies, on policies regarding science, technology and higher education, on the relations between science and society, as well as on the creation of, access to and dissemination of knowledge and information technology.

www.irpps.cnr.it

Rossella Palomba, Adele Menniti,
Maura Misiti, Piero Dell'Anno,
Alvise Forcellini, Antonio Tintori

IRPPS WPs n. 1 (2005)

Comparative Delphi report. Summary policy implications of Delphi study

*Rossella Palomba, Adele Menniti, Maura Misiti, Piero Dell'Anno,
Alvise Forcellini, Antonio Tintori*

Citazione consigliata:

Palomba, Rossella, Menniti, Adele, Misiti, Maura, Dell'Anno, Piero, Forcellini, Alvise, Tintori, Antonio. Comparative Delphi report. Summary policy implications of Delphi study. *IRPPS Working Papers*, n. 1, 2005.

Rossella Palomba è dirigente di ricerca presso l'Istituto di Ricerche sulla Popolazione e le Politiche Sociali del CNR (e-mail: rossella.palomba@irpps.cnr.it).

Menniti Adele è ricercatrice presso l'Istituto di Ricerche sulla Popolazione e le Politiche Sociali del CNR (e-mail: menniti.adele@irpps.cnr.it).

Maura Misiti è ricercatrice presso l'Istituto di Ricerche sulla Popolazione e le Politiche Sociali del CNR (e-mail: misiti.maura@irpps.cnr.it).

Antonio Tintori è ricercatore presso l'Istituto di Ricerche sulla Popolazione e le Politiche Sociali del CNR (e-mail: antonio.tintori@irpps.cnr.it).



Istituto di Ricerche sulla Popolazione e le Politiche Sociali - CNR

Via Palestro, 32 - 00185 Roma

<http://www.irpps.cnr.it/it>

Table of contents

1. A Policy-Delphi study on population related matters.....	4
2. Methodological approach.....	6
3. Main findings on final scenarios: a comparative perspective.....	9
4. Non priority matters for 2030.....	33
5. Policy priorities in a comparative perspective.....	42
6. Comparing SWOT Analysis.....	45
7. Desired future population trends.....	51
8. Dream for Europe.....	59
9. An European Agenda to 2030.....	65
Annex A: Country highlights.....	71
Annex B. Themes by countries present in the national questionnaires, in the final scenarios and dropped out during the fieldwork.....	91

This Report is the outcome of a co-ordinated working efforts, which benefited from the expertise of many individuals.

Chapter 1 is written by Rossella Palomba, Chapter 2 is written by Piero Dell'Anno, Chapter 3 is written by Piero Dell'Anno and Rossella Palomba, Chapter 4 is written by Adele Menniti and Rossella Palomba, Chapter 5 is written by Piero Dell'Anno, Chapter 6 is written by Maura Misiti, Chapter 7 is written by Adele Menniti, Chapter 8 is written by Alvise Forcellini and Antonio Tintori, Chapter 9 is written by Piero Dell'Anno, Adele Menniti, Maura Misiti, Rossella Palomba and Antonio Tintori. Annex A is taken from the National Final Reports.

Antonio Tintori prepared data and information for tables and graphs. The final language editing is due to Anthony Majanlahty and Paul Zetlin, the technical editing is due to Wanda Toffoletti.

We thank Walter Imperiale for some specific technical support in the graph preparation.

Our special thanks go to Wanda Toffoletti for her technical support during the whole duration of Delphi study.

1. A Policy-Delphi study on population related matters

This report presents the results of a Europe-wide research project based on a policy-Delphi, whose aim was to design population and society scenarios up to 2030. The policy-Delphi is a research method particularly suitable to allow experts, working independently, to act as a whole while dealing with complex problems. The method has various applications and its major use so far has been in the forecasting area. We used the Delphi technique as a method of social construction of scenarios in the field of population and welfare policies.

Three main issues were dealt with in terms of policy developments: population ageing, family and fertility and gender roles. The three issues are socio-demographic developments which are of paramount importance for 2030 Europe: they influence the economic decisions taken at national and European level, they shape the welfare systems and impact on labour market policies and trends. In addition they modify the everyday life of European citizens through changes in the family organisation, working life and use of services.

Fifteen European countries (Austria, B-Flanders, Cyprus, Czech Republic, Estonia, Germany, Finland, Hungary, Italy, Lithuania, Netherlands, Poland, Romania, Slovenia, Switzerland) participated in the study from spring 2003 to autumn 2004. An additional policy-Delphi was conducted at the level of European international organisations.

The fundamental hypothesis on which our study is based is that the way we build up our future depends on our capacity to “dream”, to look positively beyond time boundaries and everyday life constraints. While traditionally we are programmed to design the future learning from the analysis of problems characterising the current reality, this study helps readers to identify the current opportunities that can be additionally exploited to maximise and optimise the quality of our life in the future.

In Europe there are been studies of future scenarios concerning population ageing, gender roles and family and fertility, the same issues we are interested in. The scenarios focus on “problems” and try to find solutions in the short run. But if we design policies based on current problems, the effect is that we bring the problems into the future. In other words, a problem-oriented analysis of reality is not neutral with respect to the goals of policy actions.

Social systems are increasingly complex; the speed of their development limits on the one hand the possibility of influencing them through adequate policy actions and on the other hand the overall capacity of forecasting the consequences of current policy actions. This is the reason why policy interventions based on the short or very short run to counteract unwanted emerging socio-demographic developments are often ineffective and policy measures which try to affect the negative consequences of

current socio-demographic trends very rarely represent a concrete step forward. The lesson from our study is that only by focusing upon the positive aspects of current social and demographic trends can we hope to re-shape the future or create a better future.

Policy-makers, decision-makers, pressure groups and citizens are often asking questions about the future: what will our future look like? Can we design policies which result in real improvements in citizens' quality of life? Will current political controversies be solved and how? How will current demographic issues such as ageing population and fertility decline develop in the future? These questions have not been addressed either by traditional demographic studies, which provide information about the future in term of population projections, or by existing socio-economic studies, which either focus on theories or focus on sectors of society.

The Delphi study tries to answer some of these questions through the definition of socio-political scenarios at 2030, addressing population-related policies. Scenarios are designed following the inputs, comments and suggestions provided by the 15/20 "advocates/experts" selected in each participating country (for a total of 250 experts) who collectively contribute to create the scenarios through an iterative innovative multi-method approach which integrates the Delphi technique, Appreciative Inquiry and SWOT Analysis. Experts – who are strictly anonymous – were all influential persons who may well contribute to re-shape the future.

The panels - which were set-up in each one of the fifteen countries - comprised a highly diverse set of experts, namely:

- Policy-makers
- Industrial organisations, entrepreneurial associations
- Lobbies and pressure groups
- Trade Unions
- Journalists
- Church representatives, religious associations
- Gender equity institutions
- Academics
- Representatives of the cultural world (writers, art directors, poets, musicologists. etc.)
- Local Administrators (Representatives of best practices in the field of population policies).

This report takes solely a comparative inter-country perspective on the findings of the Delphi study; a synthesis of the national findings, namely the most frequently selected national scenario, is presented in Annex A.

2. Methodological approach

This section of the Report explains the original methodology set up to conduct the field and desk study¹. The method has been based both on the use of quantitative data with statistical relevance and qualitative data. The quantitative and qualitative data have been collected and processed to design the future policy-scenarios at 2030.

Fifteen advocates/experts - who in the study are known as "panellists" - collectively contributed to create the national scenarios through an iterative multi-method approach which integrates Delphi method, Appreciative Inquiry and SWOT analysis.

The Delphi is a method for structuring a group communication process so that the process is effective in allowing a group of individuals - as a whole - to deal with complex problems (Linstone and Turoff, 1975)². To reach this objective the communication is based on feedback of individual contributions, assessment of the group judgement or point of view, opportunity for individuals to revise their views and some degree of anonymity.

Appreciative Inquiry leads community, experts and advocates to imagine, design and enact a visionary future through reflection on the best of their past experience (Suchman et al., 1998)³. Appreciative Inquiry is particularly effective for fostering dialogue and integrating perspectives across differences, and for aligning the motivation and aspirations of individuals with the trajectory and needs of the community.

SWOT analysis is an extremely useful tool for understanding and decision-making. SWOT is an acronym for Strengths, Weaknesses, Opportunities and Threats. The four dimensions are a useful extension of a basic two heading list of pro's and con's. A SWOT analysis is a subjective assessment of data which, organized by the SWOT format into a logical order, helps understanding, presentation, discussion and decision-making.

2.1 Our Approach to Scenario Planning

The basic assumption of our approach is that no one is expert about the future, the future can only be imagined and guessed out of the present. The present is characterised by a growing complexity, therefore it is important to mirror this complexity in the process which conducts us to imagine the future. We have designed a methodological approach, which integrates hard data with creativity, complexity and

¹ The methodological approach has been extensively described in Deliverable D4.

² H.A. Linstone, M. Turoff (1975) *"The Delphi Method: Techniques and Applications"* Addison-Wesley Pub. Co.

³ L. Suchman, P. Hinton-Walker, R.J. Botelho (1998) *"Partnerships in Healthcare : Transforming Relational Process"* University of Rochester Press.

social constructionism. In our approach the seeds of the future scenarios are both grounded in the population historical trends (i.e. last twenty years to date) while also deriving from the panellists' knowledge, creativity, dreams and intuitions. The dreams, creativity and intuitions are measured against scales of desirability, feasibility and importance to produce final socio-political scenarios which are characterised by a high degree of sustainability and are feasible and achievable within the future 30 years.

2.2 The Process

Scenarios have been built following the 4D Appreciative Inquiry Cycle⁴ (Cooperrider and Srivastva, 1987) and on the basis of an iterative process divided into four consecutive interview rounds during which panellists' opinions and their comments were collected.

The three topics under investigation have been: Gender roles, Family and fertility and Ageing. In each one of the four rounds in order to correlate the views and information pertaining to the three topics and for allowing the respondents to react to and assess differing viewpoints we have simultaneously considered:

- *Population trends*: panellists were asked to design desired future population trends on the basis of historical trends, their knowledge, perceptions and intuitions. Trends were submitted to the panellists attention in a graphic format (i.e. historical curves of population from 1980 to date).
- *Policy Objectives*: panellists were asked to select a variable number of policy objectives depending on the round in the field of population, given a thirty year time-frame and to list, up to three key success factors for each selected policy objective. The policy objectives are macro-policy goals which enter into the final scenarios under condition that they are selected as priority matters by a pre-determined number of panellists. Each policy objective is accompanied by a set of Key success factors. While the policy objectives are related to which policies should be attained by 2030, the key success factors identify how to attain the policy objective. Therefore, they are specific policy measures/actions.
- *Controversial Policy Issues*: panellists were asked to express their views, comments and highlight the effects deriving from the adoption, removal or the lack of the controversial policy issues proposed in the list.

Between each one of the first three rounds, data have been analysed and synthesised in a summary to be resubmitted to panellists in the next round in order to obtain their inputs, comments and criticism.

⁴ D.L. Cooperrider, S. Srivastva (1987) "Appreciative Inquiry in Organizational Life", in W. Pastore, R. Woodman (eds), *Research in Organization Change and Development*, Greenwich CT, JAITRES, 129-169.

Each one of the objectives below a predetermined threshold (this means that the objective had obtained a low level of consensus among the panellists) was not resubmitted for discussion during the subsequent round. The survival of a key success factor depended upon the destiny of the policy objectives it was related to. This means that if a policy objective did not overcome the threshold, its key success factors also disappeared from our survey.

Each country was asked to autonomously identify and select its own population policy objectives, the related key success factors and policy issues. The population policy objectives and the key success factors jointly contributed to create future scenarios that were positioned on a matrix based on their feasibility and desirability.

The panellists were asked to select among a maximum of four future scenarios the one that they wanted to see attained by 2030 and to highlight - following the SWOT analysis - the strengths, weaknesses, opportunities and threats of the selected scenario in a brief narrative form (see chapter 6).

While our Delphi-study comprises a section on controversial policy issues these are not been taken into account in this comparative analysis as these are country specific. The controversies are analysed and described in the European policy-Delphi (see chapter 8).

The results on population trends are described in chapter 7.

Desirability (Effectiveness or Benefits)

Very Desirable

Will have a positive effect and little or no negative effect
Extremely beneficial
Justifiable on its own merit

Desirable

Will have a positive effect and little or no negative effect
Beneficial
Justifiable as a by-product on in conjunction with other items

Undesirable

Will have a negative effect
Harmful
May be justified only as a by-product of a very desirable item,
not justified as a by product of a desirable item

3. Main findings on final scenarios: a comparative perspective

This chapter deals with the results obtained from the Delphi study in terms of policy priorities for 2030 as they emerge from the analysis of the final national scenarios. The core of the Delphi is to identify the main policy priorities at EU and country level concerning the three issues: ageing, family and fertility and gender roles. Each country has arrived to two or more socio-political scenarios. Each scenario includes a number of policy objectives which the panellists wish to see attained by 2030. The policy objectives are macro-policy goals which enter into the final scenarios under condition that they are selected as priority matters by a pre-determined number of panellists.

As a result the scenarios offer a complex picture of the future. The future is described in terms of a set of “wished”, “dreamt” or “desired” policy priorities expressed by the panellists. These policy objectives are not a mere utopia because respondents had to associate to each policy issue a number of so-called key success factors which indicate how the specific policy goals could be achieved. In addition, a score based on the level of desirability and feasibility attached to each scenario was indicated by the panellists (see previous chapter for details).

Each scenario has been also evaluated on the basis of the SWOT analysis so to highlight the points of strength and weakness inside the scenario and the points of opportunity and threat inside the society in general (see chapter 6.)

The combination of the various policy goals/objectives and how to attain them is country specific and describes the possible “future” a country can wish for and expect if the policy objectives suggested by the panellists were implemented. Scenarios are thus a relevant input for European policy-makers who want to deal, in an innovative way, with three relevant social issues, namely ageing population, family and fertility, and gender roles.

While the national scenarios have been already described in a previous report and delivered to the EU Commission, this chapter deals with six selected themes/problems which appear very often in the agenda of European policy-makers. The themes are the following: increase in the number of births, improvement in work and family reconciliation of men and women, changes in male and female roles, active ageing, child-friendly policies and sustainability of pension systems. All these issues were present in the survey of at least two thirds of the participating countries with one or more policy objectives, though the number of countries which maintained them until the very end is more limited (see Annex B).

The analysis carried out in this chapter takes a comparative perspective, highlighting how the same policy objective may be treated and achieved in different ways. We will present firstly the policy objectives concerning each specific theme which make up the final scenarios, comparing the country findings (see Annex B for details); secondly, abandoning the geographic perspective, all the related key success factors will be analysed together on the basis of common categories to which they may

fall. A brief introduction to each paragraph will inform the reader on the current debate at EU level on the topic.

3.1 Increase in the number of births

Population trends in the European Union have changed significantly over the past decades. Declining fertility levels and extended life duration have deeply modified the age structure of the population. In its *Social Situation Report 2002*, the European Commission writes about an ageing European society: a declining percentage of young people combined with an increase in the percentage of the elderly. As life expectancy both at birth and at retirement age continues to grow and fertility rates remain low, Europeans live longer lives but have far fewer children and grandchildren to replace them. In 1960, European women still had an average of 2,59 children; by 2000 this figure had dropped to 1,45. In particular, the Southern Member States have seen their TFR decline by 32-46% just over the past two decades. In less than 15 years, the number of Europeans in the 20-29 age group will fall by 20%, the number in the 50-64 age group will increase by 25% and the number of people aged 80 and over will increase by 50%. By 2015 one third of those of working age will be 50 years and over.

Which factors control this development? There is no clear answer provided by population experts. Researchers agree on two points: there is no one factor triggering the decline of births in Europe; in EU Member States, the strategies to counteract this tendency are as varied as the respective behaviours of the people in these states.

While population experts analyse factors likely to influence future fertility, the ageing population is eliciting substantial reaction as part of an ongoing concern with, and debate about, low levels of fertility in Europe, its possible consequences and possible options for intervention to influence fertility. Policymakers are alarmed about this development in the birth rate and ask whether and to what extent the declining number of births is a development to be borne in mind when taking measures and implementing policies.

In the light of these considerations, the wishes for the future indicated by our panellists become very relevant.

In nine countries - Austria, Cyprus, Czech Republic, Estonia, Germany, Hungary, Italy, Poland and Slovenia - the need of increasing fertility has been considered a policy priority for 2030. In all the countries this policy objective has been rated as highly desirable and possibly feasible with Austria being the only exception rating it as possibly desirable and possibly feasible⁵. Therefore, we may conclude that the panellists perceived some difficulties in the implementation of policies aimed at

⁵ We recall here that in the desirability scale a policy is Desirable when has positive effects but also minor negative effects and a modest impact on the reality change, while a policy is Very Desirable when has no negative effects and a high impact on reality change. In the feasibility scale, a policy is Possibly Feasible when there are some indications that it is not immediately implementable, while it is Highly feasible when there are no obstacles to its implementation.

counteracting the declining fertility trends, though they rate the objective as highly desirable and doubted the potential impact of family policies on fertility.

We also note that in Switzerland, although no policy objective relating to the increase in fertility has been included in the final scenarios, the need for increasing the number of births was one of the key success factors associated with the sustainability of the pension system.

Are there different ways of implementing a policy to increase the number of births in the EU countries? We grouped the various key success factors associated to the policy objective of increasing the number of births in four categories: financial incentives, availability of infrastructures and services, changes in the organisation of work, changes in values and social environment. At a first glance, we can see the major differences within countries (Graph 3.1).

Graph 3.1 –Key success factors for increasing fertility by categories and countries

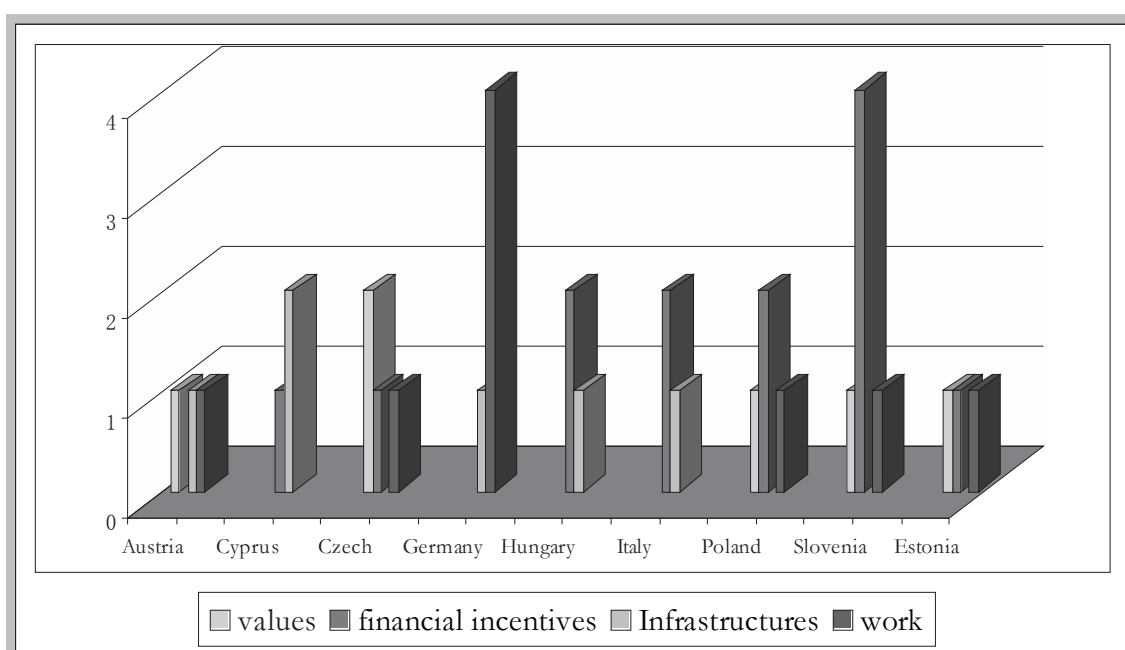

In some countries, panellists focussed their wishes mainly on one group of measures, in other countries the opinions were better balanced among all the categories. In Germany, for example, the wish for changing the organisation of work far exceeds the others. In Slovenia, panelists ask for an improvement in financial incentives, mainly for young couples who wish to have children. Other countries do not show clear preferences.

In summary, improvements in financial incentives for families with children seem the most popular desire expressed by the panellists followed by the need for changing work organisation (Graph 3.2).

Graph 3.2 –Key success factors for increasing fertility by categories

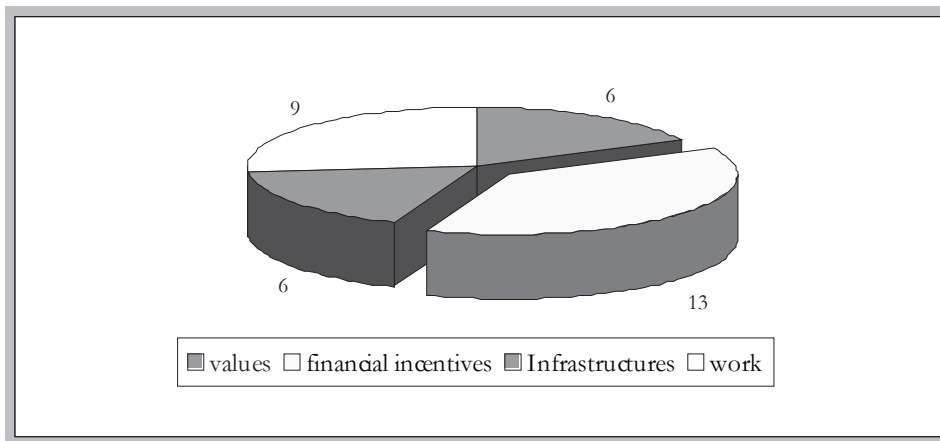

If we look more closely at the desired financial incentives indicated by the panellists, we see that an increase in the economic support to families with children is the most frequent key success factor, followed by the wish to lower the costs for education (Graph 3.3). The latter is a key success factor present in almost all the countries in transition which perceive it as a very important obstacle to the increase in fertility.

Graph 3.3- Number of financial incentives by categories

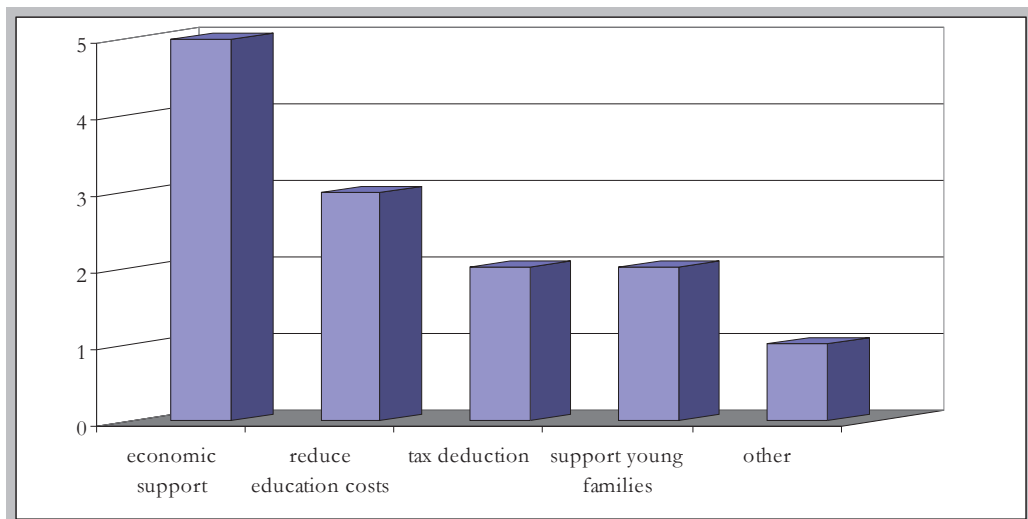

The key success factors associated with an increase in births through changing work practices and work organisation are more innovative in the demographic field - where the “pay-for-children” measures are historically asked for - and clearly connected to the work and family balance issue. Austria desires a more family-friendly environment, Poland wishes for an increase in part-time and flex-time jobs, Germany wishes for both these measures. The idea of considering the childrearing period as a working period in the calculation of pensions has also been put forward by the German panellists.

New and old measures appear in various combinations at country and inter-country level. As expected, the measures proposed depend largely on the contextual background where the decline in fertility takes place. It should be noted that, in the panellists' opinion, economic incentives alone are not sufficient to counteract the trend of decreasing fertility. These measures do not, in fact, introduce any systematic or substantial change into the culture and organization of work which is considered one of the major obstacles to realising the desired fertility. The core of the problem is therefore to somehow overcome the profound separation still characterising the world of work and the family.

3.2 Improvement in the work and family reconciliation of men and women

Compatibility between work and family is an area of research that has relatively recently acquired importance in the economic, sociological, psychological and demographic fields. Intimate relationships and daily interactions between household members are clearly influenced by the economic role of women and men in the labour market and the unpaid-work activities carried out for the functioning of the family.

The 1990s were years of major changes with regard to technological innovation and market economy, that could have had a major impact on families and the possibility of reconciling work and family. Labour market changes for example have created greater flexibility and greater employment opportunities for mothers but there is less job security and less fiscal support for families. The link between State, market and family has become more varied. Gender roles within both families and the workplace have become less sharply defined though equality between men and women in the labour market and the home is still a "virtual reality" for many Europeans. These changes intersect with each other in a complex and diversified manner. Welfare policies have been stimulated by these changes and are showing a greater concern for measures aimed at reconciling career with family needs or promoting a more equal sharing of family responsibilities between the partners in a way better suited to today's society (European Commission, 2001)⁶.

Among the various political and social considerations aimed at improving family and labour policies in the EU, one of the most important considerations in recent years has been the attempt to promote a greater participation by women in the labour market. In fact, despite the widespread increase of unemployment in all the European countries, governments are trying to increase female employment as a means to produce greater opportunities for social inclusion, to reduce the dependence of families on welfare systems and in the long term to counter the fall of the labour force due to the decrease in fertility. Achieving the average target of female employment of 60% as decided at the Lisbon Summit (2000) would bring an additional 10 million women into employment. This potential increase of the labour force, so important in the light of increasing demands on the welfare system due to population

⁶ European Commission. 2001. Annual Report on Equal Opportunities for Women and Men in the European Union 2000, COM (2001) 179.

ageing, has encouraged governments to intervene in favour of working women and to take on board the issue of work and family balance.

In the light of these considerations, the wishes for the future indicated by our panellists become very relevant.

Four policy objectives concerning work and family reconciliation made it to the final national scenarios. Romania was the only country where this issue was not considered a priority in the final scenario (Table 3.1), though one policy objective (namely: “To enable people to combine several goals in life such as a job or education with children) was included in the questionnaire with twelve key success factors of different nature.

In all the other countries, work and family reconciliation was considered a policy priority for 2030, either under the Family & Fertility issue or under the Gender Roles issue; in some countries work and family reconciliation was present under both the issues (Table 3.1).

Table 3.1: Policy objectives concerning work and family reconciliation by country and issue

	A T	BE2 ⁷	C Y	C Z	D E	EE	F I	H U	I T	L T	N L	P L	S I	SW
Family and fertility														
To enable people to combine several goals in life such as a job or education with a family	x	x	x	x	x	x	x				x	x	x	x
Gender Roles														
To enable people to combine several goals in life such as a job or education with a family	x				x	x		x	x	x	x	x	x	x
Promote equal division of work and care between men and women											x			
Promote flexible forms of parents employment												x		

Reconciling work and family was mostly rated as highly desirable and possibly feasible in the desirability and feasibility scales. As a consequence we may conclude that, in general, the panellists perceived some difficulties in the implementation of policies aimed at realizing improvements in the work and family reconciliation of European men and women, though they rate the issue as highly desirable.

In a comparative perspective, it is very relevant to look at how the panellists wish to see the policy objectives implemented because this may well depend on the national, political and social context and highlight interesting country differences.

We grouped the key success factors concerning the implementation of work and family reconciliation policies into three groups with respect to the content of the policy intervention (Graph.3.4).

⁷ BE2 is B-Flanders in all the tables.

Graph 3.4: Key success factors for improving work and family reconciliation

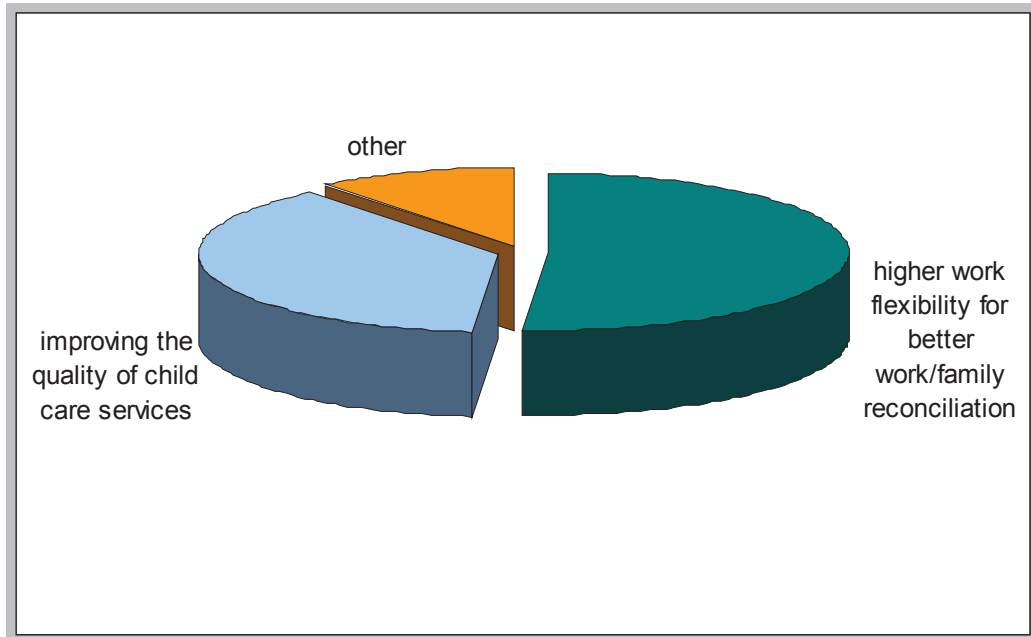

In all the countries, the attention of panellists seems to be mainly focussed on changes in the labour market aimed at increasing flexibility of working times as a tool to realize a better work and family reconciliation. Next is the wish for an improvement in facilities for child care.

Looking in more detail at the measures suggested for improving work-family reconciliation by means of changes in working time, most of the countries wish a reduction of the working time (Graph 3.5). Czech Republic, Poland, Slovenia, Hungary and Italy would like to see by 2030 an increase in the number of part-time posts; Austria, Estonia, Finland, Germany, Poland and Switzerland wish an increase in the flex-time opportunities, while tele-work is suggested only in Slovenia and Czech Republic. The integration between private life and work may also be dealt with at the individual, company or job context level. Finland, The Netherlands and Switzerland suggest policy measures aimed at realizing a better integration between private life and work focused at the individual level and believe that firms should become more sensitive and open to the requests of their employees based on family needs.

Graph.3.5 Key Success factors for improving work and family reconciliation by higher work flexibility

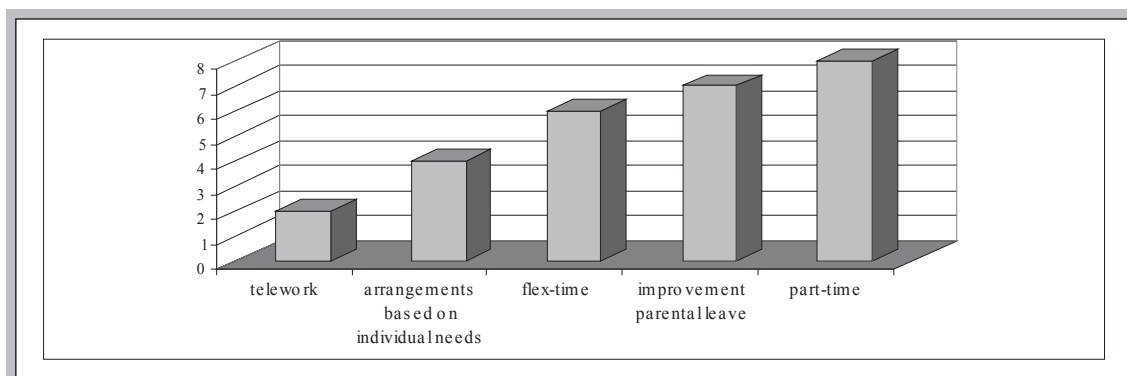

We may conclude that those countries where part-time work is less common ask for policy measures supporting and encouraging an increase in part-timer positions, whilst the countries where part-time positions are common place wish for an increasing flexibility and individualisation of working time. The latter is extremely relevant for those countries more sensitive and attentive to the need for guaranteeing their citizens the right to greater freedom of choice and the more equal opportunity to both work and have a family. The wish for improvements in parental and maternity leave was also indicated in many countries.

Improvements in the quality of child-care facilities may help working mothers and parents. In most of the countries an increase in the number of crèches and kindergartens (Graph 3.6) is desired. Austria, Flanders, Lithuania and Poland wish a prolonged school time or after-school facilities to give parents a better opportunities to work.

Graph 3.6: Key success factors for improving work and family reconciliation by child-care facilities

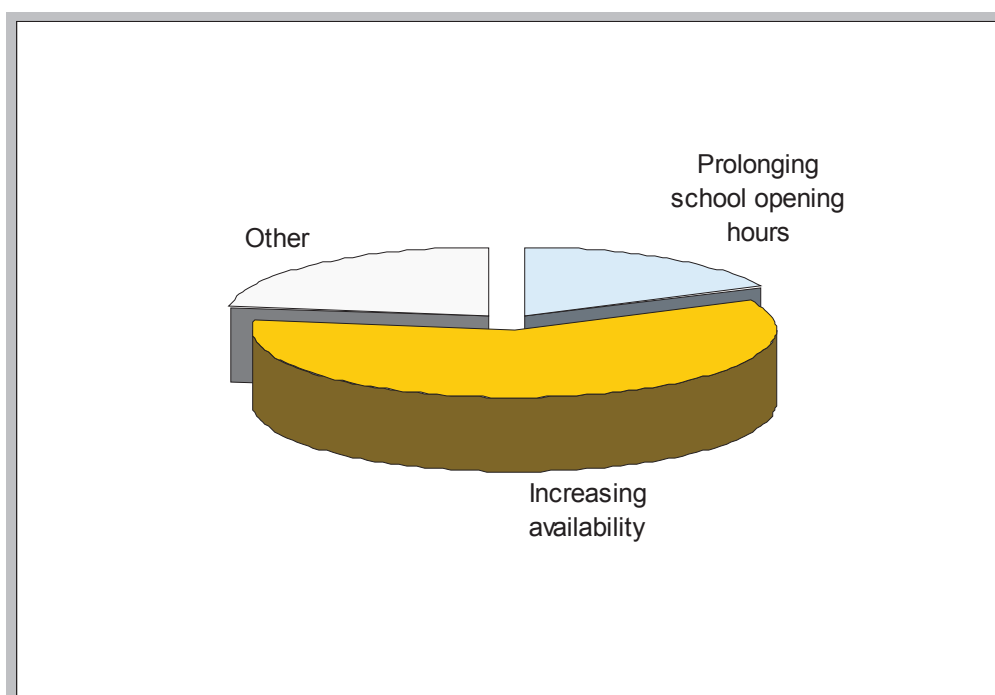

Better work and family reconciliation may also be realised through changes in values and gender roles. Six countries considered this perspective with the need for changing values taking the lion share (Graph 3.7).

Graph 3.7: Key success factors for changing work and family reconciliation by changing attitudes

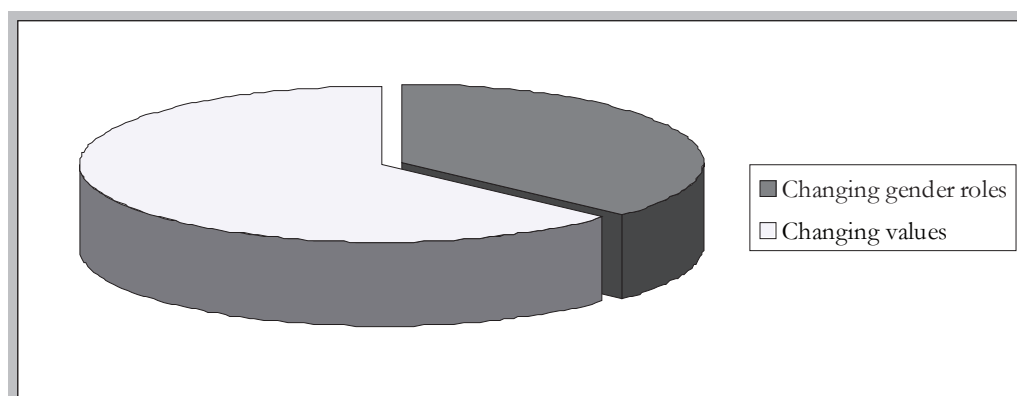

Two countries, namely Poland and the Netherlands, desire changes in the attitudes of employers towards their employees who have children thus reconsidering the possibility of also introducing family-friendly labour market laws from the perspective of changes in attitudes. Other countries namely Slovenia and Czech Republic, would like to realize a better work and family reconciliation by means of an increase in the social value of the family. Media campaigns may help to realise this objective as suggested by the Slovenians panellists. It should be noted that Czech panellists wish to shift away from a performance oriented society in 2030 and thus overcome the dichotomy between the two parts of life, work and family.

Poland, Cyprus and the Netherlands also highlight the relevance of changing gender roles, promoting an equal share of family tasks between men and women.

3.3 Changing male and female roles

In Europe, which culture is ostensibly based on equality, males and females continue to be treated differently. Males and females cannot escape the gender roles that society has placed on them, even though those have been changes that have narrowed the differences.

From the time they are born, straight through adulthood, men and women experience the limitations that gender roles put on them. In our time, stereotypes still play an important part of the game in allocating roles and tasks to each gender and even in those cultures where gender roles are in a better balance, there are still stereotypes that limit the full development of individuals, making it difficult to step out from the most socially accepted roles.

In Europe, men are still largely perceived as breadwinners even though this does not longer correspond to the existing social structure of our societies, while women - even if playing three roles (production, reproductive and family-management) at once - are still mainly perceived as the family carers.

Even though the change in the man's social role in society has proved to be very slow, men are starting to break with traditional forms of masculinity via their higher involvement as fathers. This has been helped by the intervention of Governments in some European countries where paternity leave has become socially - accepted option to run concurrent with the traditional maternity leave.

Gender roles exist from early into our childhood and into our adult life have a massive impact on our behaviours and attitudes. While gender roles exists from childhood, this become more evident, having a higher impact on our lives once individuals join the labour market and/or establish a family.

In the job market, there are distinct differences in both the types of careers and salaries males and females receive. The imbalance of work and family responsibilities are at the heart of our research.

The comparative analysis of data from the 15 countries involved in our research highlights that in four countries (Estonia, Finland, The Netherlands and Slovenia) none of the objectives on changes in gender roles have reached the last phase of interview and contributed to the design of the scenario at 2030. In the remaining countries, the gender roles matter has been modelled through 5 policy objectives which can be summarised in two macro areas, namely: change in the stereotypes affecting the development of each gender and promotion of actions to model new identities for men and women.

Table 3.2 Policy objectives on males' and females' roles in the scenario by country

POs	A T	BE2	C Y	C Z	D E	H U	I T	LS	P L	R O	SW
To remove stereotypes on gender roles	x		x	x		x	x	x	x	x	x
Promote the role of fathers within family/housekeeping		x									
To learn about gender roles at school					x						
To promote responsible fatherhood									x		x
To increase the input of fathers for the care and education of their children					x						

The level of desirability of these objectives is predominantly high, with one exception (Romania), while the feasibility level varies between high and possibly feasible according to the action in analysis.

Table 3.2 highlights that in order to change the gender roles, there is a widely-held perception in Europe of a need to counteract the current stereotypes. In fact the majority of (9 out of 11) countries that have brought to the final scenario a change at gender role level, this objective is reported.

Looking at the specific actions to be undertaken to overcome gender stereotypes and to promote new roles for each gender, two main factors are considered fundamental to enact the cultural shift, namely: the school and the media.

The school is called to promote and support specific projects and programs to support gender equality, while the media should promote campaigns to respect gender diversity, which does not mean the enforcing of gender stereotypes but simply the respect of gender differences for the achievement of gender equality.

Last but not least, the media are also perceived as a sensitisation carrier to promote gender equality.

In terms of role changes, as shown in the Graph 3.8, it appears that men should be more involved in the family management and the care of children in order to acquire a fair balance between gender.

Five out of seven countries who have suggested a male role change in their societies suggest that these changes should foster a higher participation of men in domestic chores and fostering equal distribution of child care.

An opposite scenario is expected for women's role in our society as highlighted by our panellists. Women should acquire better and more visible positions in the labour market and in the social, economical and political life.

Graph: 3.8: Key success factors for changing gender roles by increasing men participation in household tasks and child care

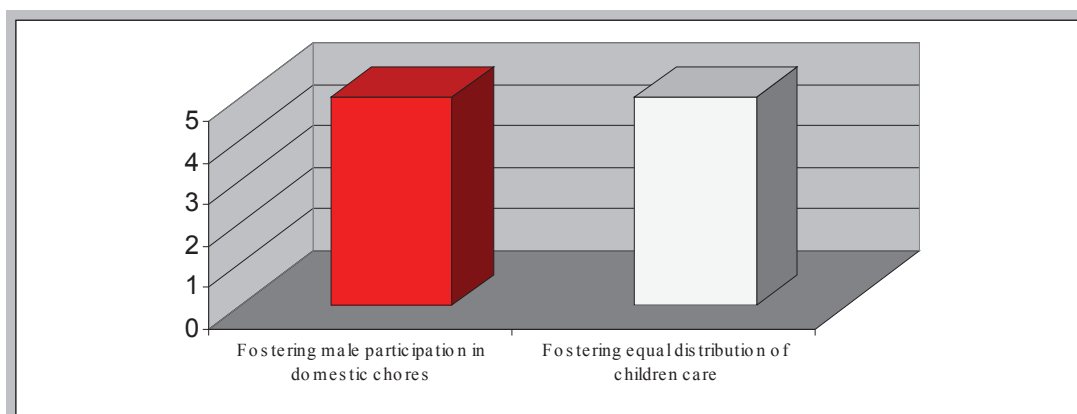

In brief words, more men at home and more women outside home and when outside home and moreover women should be guaranteed to have the same opportunities as men to play an active and decision-making role in the development of our societies. Last but not least, there is a series of additional actions that should occur in our societies to guarantee a change in the behaviour and attitudes of both men and women. These are mainly changes in labour market legislation that can guarantee fair access for both men and women to all job positions and more job opportunities. Changes in family policies should guarantee equal rights for both

fathers and mothers. This, in the view of our panellists, should be obtained by making paternity leave mandatory, ensuring the non-transferability of this right between parents and by promoting co-parenthood beyond separation and divorce.

It is worth noting that some of the policy actions regarded as fundamental in the renewal of gender roles by our panellists coincide with those chosen by the European Union to Promote Change of Gender Roles and Stereotypes as part of its Community Framework Strategy on Gender Equality.

In the context of establishing a change in gender roles it is supposed to bring about different actions involving awareness (media), education and structural components.

3.4 Active Ageing

The notion of active ageing emerged first in the field of gerontology, with the aim to preserve the active role of senior citizens in civil society. The issue of active ageing is concerned with essentially the question of well-being in old age where *“the process of optimising opportunities for health, participation and security in order to enhance quality of life as people age”*⁸.

A few years ago, the notion of active ageing was introduced in to the field of pension policy. The practice of early exit from the labour market has been increasingly criticised and is one of the main topics discussed during the debating of potential reforms to the various pension systems in Europe. Nowadays it seems that ‘active ageing policy’ encourages older workers to stay as long as possible in the labour market. Therefore, the notion of active ageing has been reformulated and used in a way other than that for which it was created. Today, active ageing does not mainly concern the quality of life for older people but has been redefined to emphasise their productive dimension. In fact, *“Active ageing refers to the capacity of people, as they grow older, to lead productive lives in society and the economy”*⁹. In this way, the notion of active ageing is being transformed according to the policy change: created to promote the well-being of older people, essentially through political measures concerning healthcare and long term care; it has then been modified to include the participation of the elderly in the labour market and nowadays it is also associated with the policies of pension and employment. The concept of active ageing has been additionally enlarged and nowadays encompasses activities like voluntary work, leisure time and life long learning.

Out of the fifteen countries addressed by our policy Delphi, 11 have brought the active ageing topic to the very final round, considering it as a priority to be achieved by 2030 (Table 3.3).

⁸ WHO, Active ageing – A Policy Framework, UN-World Assembly on Ageing, Madrid, April, 2002, p.12.

⁹ OECD, 1998, Towards an employment-centred social policy, *Employment Outlook*, Paris.

Table 3.3: Policy objectives on active ageing in the scenarios by country

POs	AT	CZ	EE	F I	IT	LT	NL	PL	R O	SL	SW
To make retirement flexible											X
To promote active ageing		X				X	X	X		X	
Support the employment of the elderly	X				X		X				
Promote social participation/integration of the elderly		X			X		X	X	X		
To pay attention to the elderly needs in technological development				X							
Lengthen the active life span			X								
Support individual active preparation for old life		X									

A closer analysis of the policy objectives' level of desirability highlights that the majority of them are regarded as highly desirable, while the level of feasibility is split quite equally between highly and possibly feasible.

In our study, active ageing, as shown by the list of policy-objectives in table 3.3, has been used to investigate a process involving work, life long learning, voluntary work, leisure and health. Those five components contributing to the model of the active ageing concept are hereby analysed.

Working activity of the elderly has been considered by the panellists from two different points of view, namely: paid work and voluntary or unpaid work. Concerning paid work of the elderly, in order to sustain active ageing up to 2030, two main streams of interventions were highlighted by the panellists: one addresses the duration of daily work and the other is more structural and addresses age limits at retirement and related implications

In terms of duration of working days, as shown in Graph 3.9, there are four countries, namely: Austria, Czech Republic, Italy and Switzerland, who wish to promote the adoption of part-time work for senior workers or the introduction of innovative forms of part time work.

Graph: 3.9 Key success factors for active ageing by paid work regulations

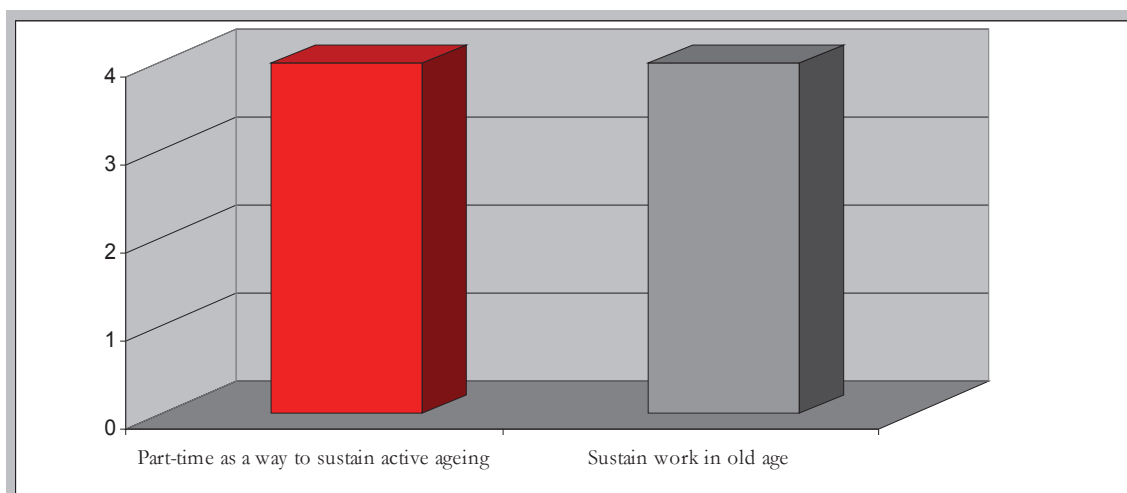

The Netherlands, Estonia, Austria and Poland, on the other hand, are more concerned with interventions that guarantee the participation in the labour market of senior workers through the reduction of their work-load, by allowing the elderly to continue to work after retirement or by removing old-age barriers in the labour market. Estonia suggests, for example, to gradually reduce the work-load of senior workers. Alternative structural interventions are forms of vertical job-sharing, tax-exemption for those firms which hire retired persons and last but not least the adoption of leave during work life as a form of anticipated retirement during work-life.

Active ageing can also be sustained by a variety of interventions addressing voluntary work (6 countries have indicated this typology as a priority to address active ageing up to 2030), some of which are highly specific and some others which have a more comprehensive nature (Graph 3.10).

Graph: 3.10 Key success factors for active ageing by unpaid work

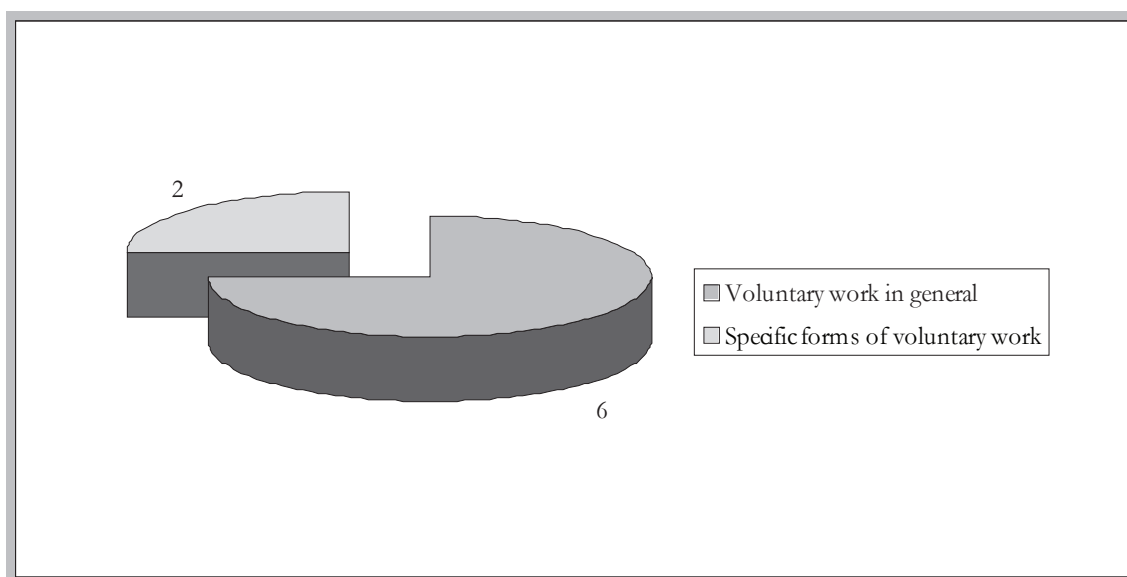

Under the more general approach to voluntary work we find actions to promote social awareness in the area of seniors' voluntary work or aiming to increase the relationships amongst elderly and local communities but also actions to promote pilot neighbourhood projects. More specific forms of interventions in the area of voluntary work are: to increase the engagement of the elderly in child-care activities (Slovenia), to stimulate the guidance and coaching of young people in schools (The Netherlands).

Life long learning can also play an important role as a tool to sustain active ageing. This is what five countries from north and eastern Europe believe (Graph 3.11). Life long learning can be promoted via senior universities or specific training courses to be deployed before and/or after retirement. Three out of the four countries who consider this as a strategic factor to maintain the older component of our population active beyond retirement believe that learning via *ad hoc* training courses would be able to sustain the process of active ageing. Polish panellists believe - the other side - that university education should not simply occur while young but also beyond our working middle age life.

Graph: 3.11 Key success factors for active ageing by long life learning

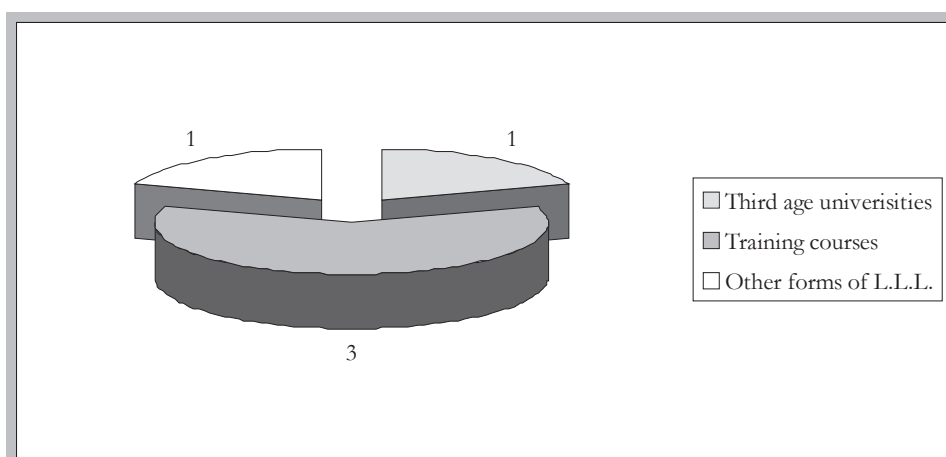

Last but not least The Netherlands has also suggested that active measures regarding schooling and employability should be taken in order to favour a higher and more engaged presence of the elderly by 2030.

Health has certainly a key role in fostering an active ageing approach to life. Health is tackled at two levels by the countries in our study, namely healthy living and health services. The concept of healthy living has an holistic dimension by considering health in terms of work relationships, nutrition, body fitness, etc. Our comparative study shows that out of the fifteen countries taking part in our research, only 8 have considered active ageing as a priority to be undertaken by 2030 and of this 8 only four consider a healthy approach to life a key component in fostering active ageing.

In terms of actions to sustain a healthy living as a key component of active ageing these are comprised under two main headings, namely: healthy way of living and health services (Graph 3.12).

Graph: 3.12 Key success factors for active ageing concerning health

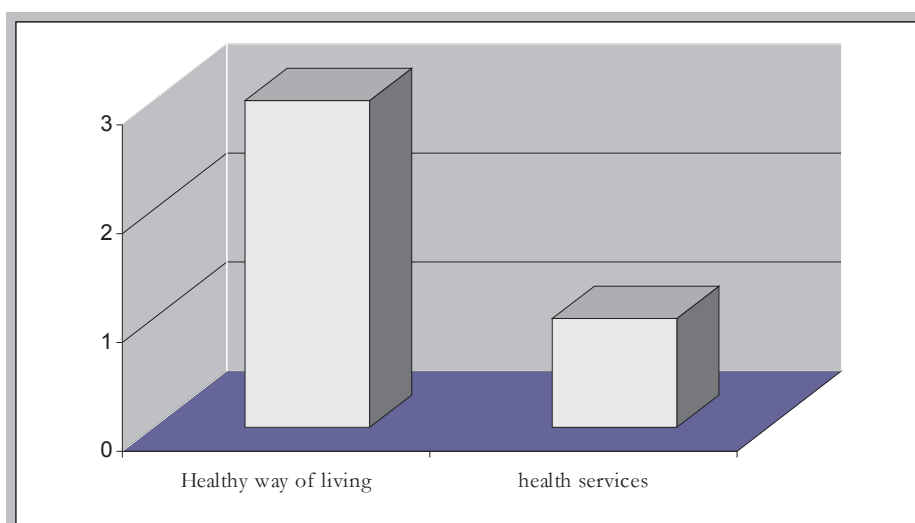

The first addresses mainly people's life style and comprises actions such as avoiding forms of exploitation of employees, lifelong health check-ups, regular physical work-out and an accurate health education.

The latter is more concerned with infra-structural interventions as the development of services and infrastructures purpose-designed for senior citizens. It is quite interesting to note that out of the 4 countries which have indicated the health component as a priority to guarantee active ageing three are from central and eastern Europe, possibly indicating that in these countries a lot has to be done in terms of awareness and practical interventions in the area of seniority and healthy living.

Last but not least the leisure component has also been taken into consideration in the process of consolidating active ageing. As for the health variable, the leisure one is also addressed via a series of actions collected under two main headings, namely: leisure activities that foster active ageing and purposely built infra-structures for leisure activities.

As shown in Graph 3.13 three countries have suggested interventions in the area of improvement of leisure activities (Czech Republic, Poland, Slovenia) while the Czech Republic has highlighted as a priority, the development of public spaces that could enhance the gathering of seniors.

Graph: 3.13: Key success factors for active ageing concerning leisure time

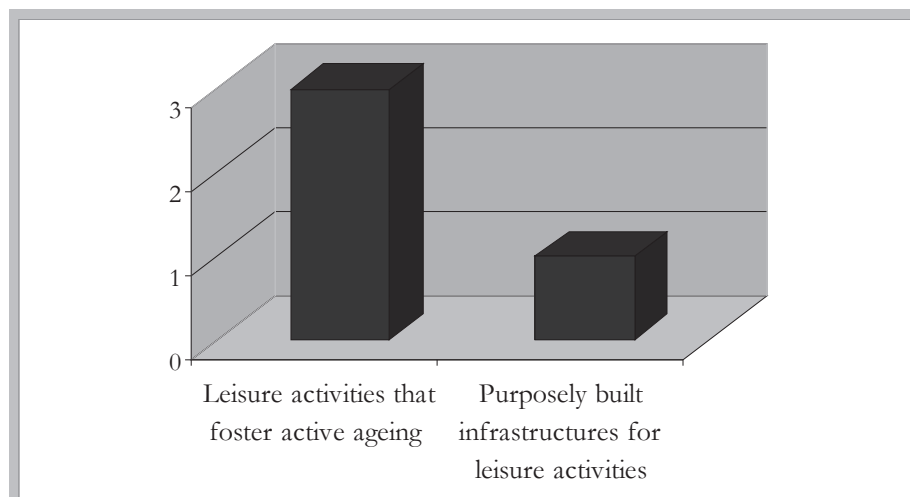

Leisure time should be sustained at pre-retirement age, possibly free of costs and involve an educational component.

3.5 Child friendly policies

Family benefits have the worthy nature to promote equity and equality within families and to sustain - if not guaranteeing - child development, but of course not all policies have equal effect and equal impact in pursuing these goals.

Child friendly policies have a diverse nature in the different countries in Europe and this is reflected in the findings of our comparative report. Prior to describing them it is worthwhile to have an overview of the current European trends in the area of child friendly policies.

Child friendly policy is a vast area of investigation comprising measures that directly address the child's development but also directly and indirectly target parents. A direct target of child friendly policies is often the mothers especially when they play an active role in the labour market.

The growth in the number of working mothers has generated a complex phenomenon which involves the work and family reconciliation of families, gender equity issues in the work-place and others. This phenomenon has obliged policy-makers to adapt the existing legislative framework to the newly emerged scenario.

Being a mother and wishing to build a successful career is a difficult mission and women will be unlikely to succeed - in large numbers - unless society at large understands that women's advancement in the labour market is at risk unless thoughtful actions are taken to resolve the conflicts between work and family that disproportionately affect women. Society should acknowledge that, with a growing number of mothers in the labour market, other arrangements must be made to ensure that young children grow and develop well. If the phenomenon is observed simply with a speculative eye, with regards to socio-economic interests, we certainly cannot avoid asking ourselves, how mediocre or poor investments in this area will impact on today's child development and their progression into tomorrow's citizens and workers?

Up until quite recently the most recurrent benefits for family with children have been family allowances and parental leave, a leave which in substance was a maternity leave. These benefits are no longer adequate to help families and children to face the complex management of today's life and child development, and its inadequacy grows when compared to the future of families and children.

In our research we have asked 15 countries to think and dream desirable and feasible alternatives to the current reality in terms of child friendly policies, some of which are described below.

Overall there are two policy objectives that establish a common ground in some of the European countries addressed by our research (Table 3.4).

Table 3.4: Policy objectives on child friendly policies in the scenarios by country

POs	CZ	EE	IT	LT	PL	SW
To create a child-family-friendly environment	x	x	x			x
To provide equal opportunities for children of all social strata to acquire the desired high quality education				x	x	

They intervene, via their actions, at four levels, namely: Financial dimension, via the adoption of child friendly allowances; Care services directly benefiting children; Care services for the benefit of families with children; Others (Graph 3.14).

Graph 3.14: Key success factors for child-friendly policies

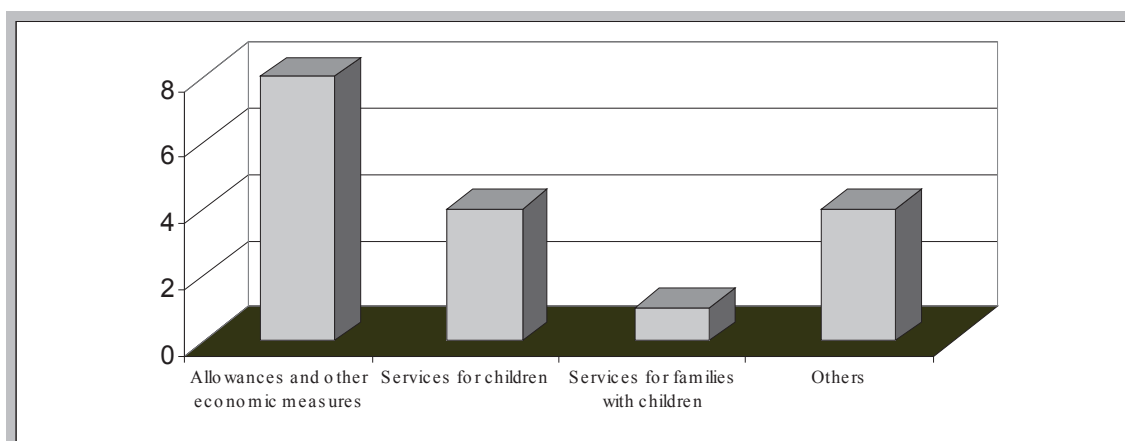

By 2030 Italy, Switzerland and Lithuania are keen to see allowances and other economic measures, such as the provision of supplementary benefits for needy families, reduction of the health insurance premium, significant reduction in education costs especially for children of disadvantaged groups and other intervention of economic nature.

Care services directly benefiting children are aimed for by the Czech Republic, Estonia and Italy and they include: an increase of the quality of education by the restriction of the number of pupils per classroom, an improvement of child-friendliness of neighbourhoods and a structural intervention in terms of quality and quantity of care services for children.

The Czech Republic believes that in order to create a child family friendly environment social services and institutes that provide care services should be upgraded so to become available to family with children.

More general actions in the context of family friendly policies are requested from Estonia and Italy and these comprise: improvement of services to prevent violence within schools, to reduce the school drop-out and avoidance rate and

awareness campaigns that sustain a better use of the environment and public resources.

With the exception of Switzerland whose intervention in the field of child friendly policies is solely in the economic area - probably showing a sound activity in the field from a service point of view - all other countries are calling for an improvement of the quality and quantity of services affecting children's development. The latter are from Eastern Europe and Italy.

Italy is not only the sole western economy wishing for an improvement in this area but also the only one wishing for an improvement in terms of financial allowances, services for children and services for families with children, probably signifying poor intervention of the Government in this field, and possibly poor public and private provision of children's services generally.

Last but not least there is a desire for child-friendly policies that predominantly intervene in terms of improvement of the quality and quantity of services and less so in the form of allowances. This fact possibly indicates that, in the future, families will be very much concerned with the quality of life of their children and they will seek more assistance in the organisation and support of their household's commitments.

3.6 Sustainability of Pensions Systems

Future and uncertainty are long term companions. The future has always been characterised by a certain degree of uncertainty. During the coming decades however, the European Union will be confronted with a certain degree of certainty: the non-sustainability of many of its pension systems. Or, if one might wish to stay positive and, approaching the question from a more intellectual and scientific point of view, we could simply say that Europe will face the challenge of studying, finding and adopting programmes, projects and actions that can or will guarantee pensions' sustainability.

The problem of ageing population, the secular decline in mortality and the resulting increase in life expectancy matched with a decline in fertility, are issues that were forecast a long time ago and which are certainly quite complex in their way of affecting the sustainability of pension systems.

A complex issue which seems to be approached by many policy-makers in quite a simplistic way. In fact the public debate on pension sustainability is tackled, mainly, if not solely, from an economic/fiscal edge while the subject comprises many more issues than simply monetary ones.

Only recently, some countries have adopted different ways of tackling the problem of pension sustainability over the years and increasingly the current debate and interventions are focussing on "rethinking and readapting" pension schemes to the changes in population in terms of the quality of life of the elderly.

The retirement schemes simply based on age and not on an individual's capacity to be productive and effective despite their biological age have become inadequate.

The OCDE encourages the development of new policy instruments : financial incentives for employers and employees, specific programs for old unemployed people, lifelong learning in order to preserve the ability to work. In the same way, the EU has denounced the massive use of early exit schemes.

The issue has become important with the introduction of the Open Method of Coordination and its application for the elaboration of a European Concerted Strategy of Pension Reform.

At the Lisbon Summit (2000), the Economic Policy Committee and the Social Protection Committee, recently created, have been charged to realise reports to evaluate the situation of the pension reforms in the Member States and to make some recommendations. The joint report proposed eleven objectives. With the agreement of the Member States, three main common goals have been defined:

1. the Commission's recommendation is to respect strict budgetary target and to slowdown the increase in public spending. This could lead to the development of a multi-pillar system and the introduction of private supplementary schemes financed by capitalization.
2. the Council underlines the necessity to raise employment rates. The dependency ratio (number of people over 65/ number of persons between 15 and 64) will double by 2050. The acceleration of demographic ageing should be partly contained by an improvement of the employment ratio (proportion of inactive people/proportion of active people). At the Lisbon summit, a quantitative objective was set: to attain a global employment rate of 70%, and of 60% for women by 2010. A few months later, at the Stockholm Summit, the Council fixed another objective specific to older workers: to raise the activity rate to 50% for the workers between 55-65 by 2010. At the Barcelona Summit, the Member States also agreed to encourage older workers to work five years more by 2010.
3. the third objective is to adapt pension systems to the demographic, economic and societal changes, by taking into account the new forms of employment (flexibility, insecurity, periods of unemployment) and by guaranteeing intra- and intergenerational equity.

Anna Diamantopolou, Commissioner for Employment and Social Affairs has recently affirmed that: “ the ratio of pensioners to people of working age will double between 2000 and 2040 increasing the burden on public finance.

The challenge on policy-makers is to therefore ensure that the future pension financing does not destabilise budgets, and that at the same time pensioners remain adequately protected”.

This is a goal which carries an obvious monetary issue, “ensure pension financing without destabilising budgets”, and a complex social one, “guaranteeing adequate social protection of the pensioners”.

In order to intervene and meet both levels of the issue society should ask itself what does “destabilising“ mean, when and if we can start worrying about budget destabilisation, how to put in place measures that guarantee pension financing and budget stability and, on the other side, how can we ensure adequate social protection of pensioners.

In our study the issue of pension system sustainability has been tackled in the fifteen countries by taking a complex perspective which looks at the future of pensions as a by-product of social changes comprising immigration, life expectancy, active ageing, social-work, various forms of employment, flexibility in the exit from the labour market, women’s role and participation in the labour market, intergenerational integration and many more.

As shown in table 3.5 the policy objectives regarding the pension system appear to target two main issues, namely: the pension financial sustainability (i.e policy objectives such as adjust public policies to the ageing population) and pensioners’ social protection (i.e policy objectives such as to secure old-age state pensions

Table 3.5: Policy objectives on “pension systems sustainability” in the scenarios by country

POs	AT	BE2	CY	CZ	D E	EE	FI	HU	IT	LT	NL	PL	RO	SL	SW
To make retirement flexible															x
Adjust social security to the ageing population and increase intergenerational solidarity	x	x	x		x		x	x		x			x	x	
Ensure the sustainability of pension system		x		x		x			x						x
To secure the old-age state pensions											x				
Lengthen the active life span						x									
To promote individual responsibility for own ageing												x			

Looking at the key success factors and in order to create a system that will ensure pension sustainability in Europe, 4 main pillars can be highlighted (Graph 3.15), namely:

1. *Innovation and flexibility of work models and pension systems* proposed by: Switzerland, Austria, B-Flanders, Cyprus, Germany, Finland, Hungary, Lithuania, Romania, Slovenia, Check Republic, Estonia, Italy, The Netherlands, and Poland.

2. *Better investment in Health improvement and Life Long Learning* suggested by: Finland, Hungary, Lithuania and Estonia
3. *Intergenerational solidarity and rejuvenation of society* recommended by Lithuania, Romania, Slovenia and Italy
4. *Gender balance in the work environment and new immigrants work schemes* indicated by: Austria, Germany and Italy.

Graph: 3.15: Number of countries by Four “pillars”

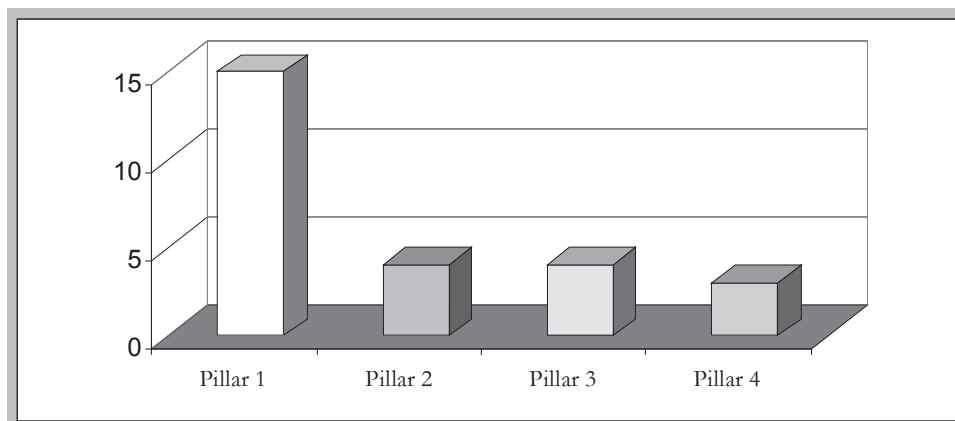

The first of the four pillars, innovation and flexibility of work models and pensions system, is the one that shows the highest interest in terms of countries that wish to see it realised by 2030, and richness in terms of actions to achieve its accomplishment (Graph 3.16).

Graph 3.16: Key success factors concerning “innovation and flexibility of work models and pensions system”

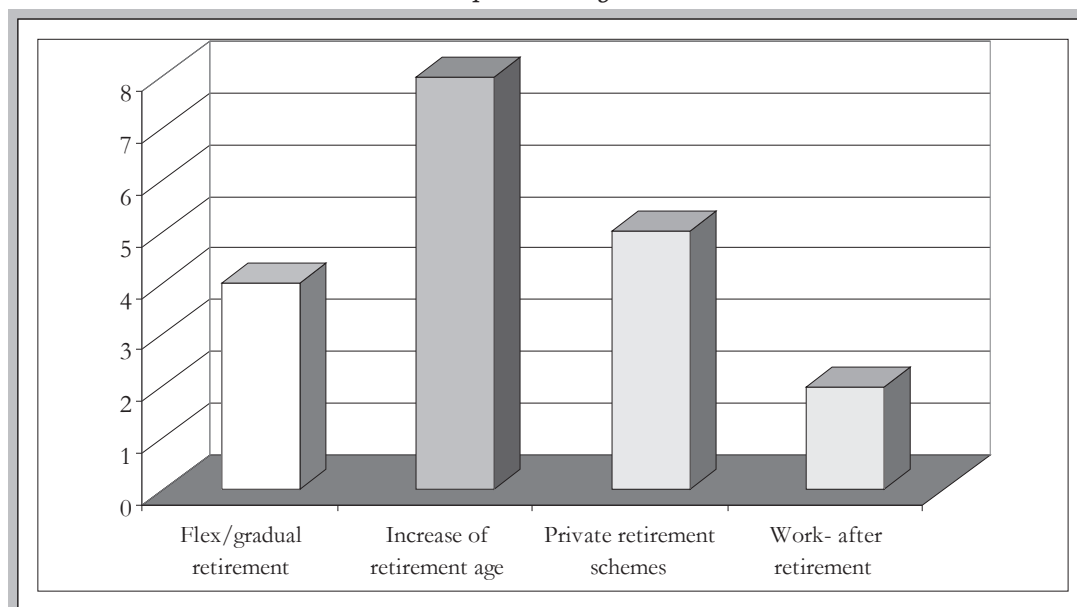

The compared analysis of the first and richest pillar highlights a common tendency amongst all countries which believe either in an increase of the retirement age or in the adoption of flexible retirement plans. A closer look shows that within this pillar, the increase of retirement age is the option that is most thought to be capable of ensuring the financial sustainability of the pension system. The widening of private retirement schemes is the second intervention considered fundamental to pension sustainability while the flex/gradual retirement and work-after retirement respectively ranked at third and fourth place in terms of their capability to assist in the rebuilding of pension systems. If we exclude the private retirement schemes - which call the workers to directly contribute financially to build their pensions, the three remaining ones directly impact, in one way or another, on work-life expectancy.

The other three pillars are all equally balanced. They are in fact considered to be means to achieve pension sustainability through their action by four countries with regard to pillar 2, better investment in health improvement and Life Long Learning, and pillar 3, intergenerational solidarity and rejuvenation of society, and three countries for the fourth pillar, gender balance in the work environment and new immigrants work schemes.

It goes without saying that our capability to be active and productive for a very long span in the labour market is directly dependant on our good health and on our capability to renew our skills or capitalize on the existing ones in order to adapt to the constant changes occurring in the knowledge society. Despite this, the second pillar shows - when compared to the first one - a lower level of capability to contribute to pension sustainability and probably the "*raison d'être*" of this thinking is that the second pillar plays a "cause role" in the sustainability of pensions and is not as immediate as the increase of work-life expectancy which acts as a primary contributor. Within this pillar the better investments in health improvement and higher investment in increased life-long learning show an equal share in their capability to sustain the survival of pension systems in the future.

The third pillar designed to sustain pension systems in Europe proposes intergenerational solidarity and rejuvenation of society as one of the possible ways to target the issue at hand. Intergenerational solidarity and rejuvenation of society is promoted by 3 eastern European countries and Italy and actions to sustain pension systems comprise: training in intergenerational solidarity for the youth, financial incentives for those families who take care of old family members and last but not least an increase in the number of births.

The fourth and last of the pillars concerning future pension sustainability is the enhancement of gender balance within work settings and the new immigrant's work schemes. Two countries have indicated the first component of this pillar as a priority to be achieved via actions that increase the female employment rate and one, Italy, believes that a way to sustain the pension system is to increase the number of legal immigrant workers by up to 10% of those currently active in the job arena.

As illustrated, pension sustainability is a topic considered a matter of priority by all the fifteen countries involved in our policy-Delphi, showing a high degree of interest and sensitivity on this matter and its relationship with the sustainability of an ageing society.

Overall it is quite interesting to note that pension sustainability is a matter thought of as quite a complex issue which involves not simply a financial component but also a social one as well as the organisation of work, investments in adult learning and health, gender issues and immigration, and last but not least intergenerational solidarity and increase in the birth rate. This might be the source of an integrated and complex approach to be adopted, exploited and amplified in designing future policies in the area of pension sustainability.

4. Non priority matters for 2030

When analysing and discussing the policy objectives which have been included in the final country scenarios, we have focussed on six main themes (increase in the number of births, work life balance, changes in gender roles, active ageing, child friendly policies, sustainability of pension system) which were either relevant for the future European society or more frequently indicated as priorities by the panellists. As shown in previous chapters, some of these themes were considered in the national scenarios; in some countries the themes entered the scenarios but some of the related policy objectives were dropped at a certain stage during the fieldwork. In some countries the themes were not considered at all in the questionnaire (see Annex B for details).

This chapter deals with those policy objectives related to the above mentioned themes which did not make it to the very end of the process¹⁰. We will focus on those policy objectives which in the scheme presented in Annex B are listed under column C.

The analysis has two aims: to understand if one or more of the selected themes has not been considered as a priority by the panellists and to understand which policy objectives concerning the six themes have not been considered as priorities for 2030. The key success factors will not be analysed in this chapter because, according to the methodology, they were dropped as soon as the related policy objective was not selected for the next round.

We asked the focal points to highlight all those Policy Objectives dropped out during the Delphi. On the basis of the information collected we have grouped the policy objectives by categories under each of the selected main themes and compared the non priority matters among different countries.

4.1 Increase in the number of births

The need for increasing the birth rate was considered a priority for 2030 in nine countries though a total of 15 countries had included this theme in their

¹⁰ In this chapter Hungary is not included.

questionnaires both in a direct and indirect way. Out of the five countries where this issue has not been included in the final scenarios, Finland, Lithuania, Netherlands and Romania had considered the need for an increase in birth rate as a specific country priority for 2030 whereas B-Flanders and Switzerland have considered in their questionnaires issues that might be taken as proxy of increasing fertility. In addition to that, Austria, Czech Republic, Cyprus, Germany, Italy and Slovenia have dropped during the fieldwork some of the policy objectives related to the increase in births but at the same time this theme has also been included in the final scenario. Looking at the policy objectives which have been eliminated by the panellists as non priorities, 5 main categories may be highlighted (Graph 4.1).

Graph 4.1: Rejected categories of the “increase in births” policy objectives by number of countries

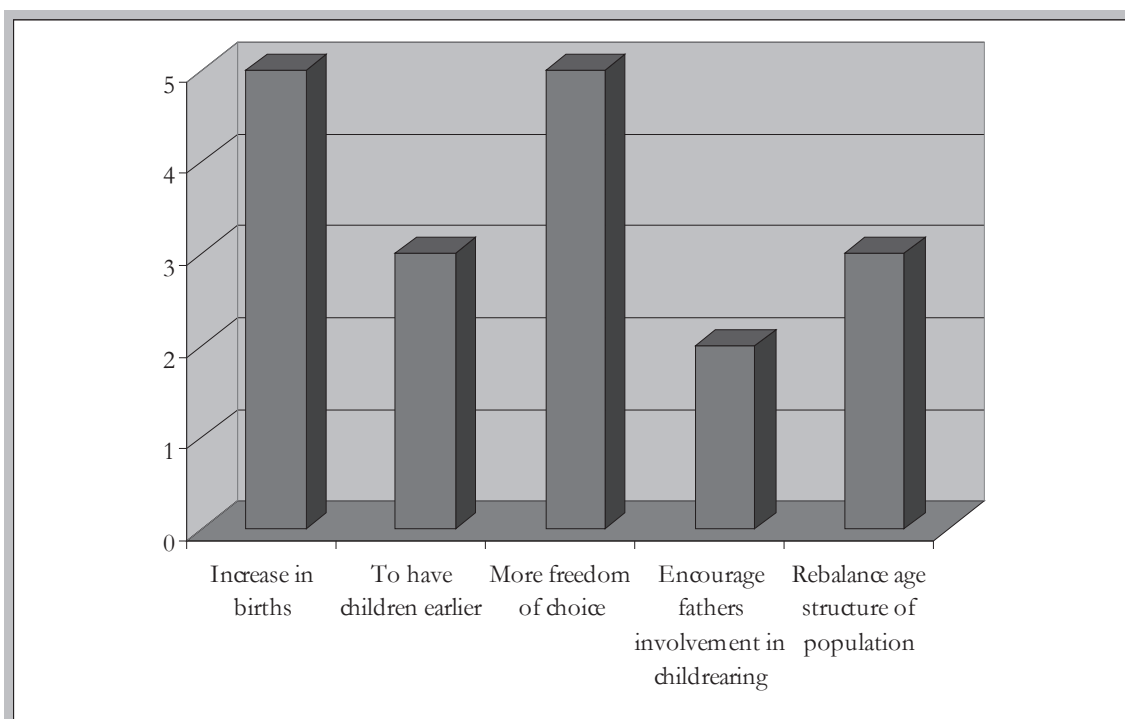

The need for giving more opportunities for choosing and deciding about the number of children has been the policy objective dropped in the highest number of countries. Austria, Cyprus, Italy, B-Flanders and Switzerland had included the need for guaranteeing more opportunities to couples wishing to have children in their questionnaire but the panellists did not consider the issue a priority for 2030.

The explicit reference to the need for increasing births was included in the questionnaire of 4 countries (Austria, Finland, Lithuania and Slovenia). In Finland the idea was to increase the size of the families, in Lithuania to increase the fertility rate, in Slovenia to slow down the decrease in fertility while Austria focused on the promotion of a higher birth rate through financial measures. In addition, three countries (Italy, Germany and Romania) included as policy objective in their

questionnaire the need for a better age structure of the population. All these items have been dropped during the fieldwork.

Three countries (B-Flanders, Czech Republic and Finland) focused on the need to counteract the trend towards postponing motherhood to later years and therefore increasing fertility. Also this policy issue was not considered a priority for 2030 by the panellists.

Finally, the need of increasing fathers' involvement in the care of children was dropped in Austria and Czech Republic.

Some of the policy objectives mentioned above have a clear demographic meaning and implication. To counteract births' postponement as well as the need for having children earlier, for example, make an explicit referral to the current fertility trends in Europe and therefore they may well be eliminated by the panellists because they are too specific.

The same may be applied to the need for a better balance in the age structure of the population which again is too specific to be considered as a policy priority for 2030. As a result, the disciplinary view of the fall in fertility has not reached the necessary consensus inside all the national panels.

When speaking about the increase-in-births policy objective, it should be noted that in Austria the policy objective related to the need for increasing the number of births through monetary measures has been dropped out, whereas the wish for increasing births through social and family friendly measures has reached consensus among the panellists. In Slovenia there is an interesting nuance to be highlighted: while the need for a slow down in the decrease in the number of births was rejected by the panel, the more clear objective of increasing births has entered the final scenario.

4.2 Work and family reconciliation

The wish for a better balance between working and family life is an issue which arrived to the final scenarios in all the participating countries. This doesn't mean that some policy objectives concerning this theme have not been dropped out during the Delphi study. In fact, in nine countries the issue of reconciling work and family, in addition to the policy objectives which arrived to the final scenarios, was present also in terms of goals which were not adequate to reach consensus among the panellists.

After grouping the policy objectives which turned out to be non priorities by categories, we obtain the picture shown in graph 4.2. As a general comment, the more specific the policy objectives concerning work and family reconciliation the more frequently they have been dropped out.

Those countries such as Lithuania, Switzerland and Romania which have included the need for improving work and family reconciliation in a more comprehensive way have both maintained the priority till the very end of the study

and dropped it out during the field work, probably because the theme was present under two different main Delphi study issues: family and fertility and gender roles.

Graph 4.2: Rejected categories of the “work life balance” policy objective by number of countries

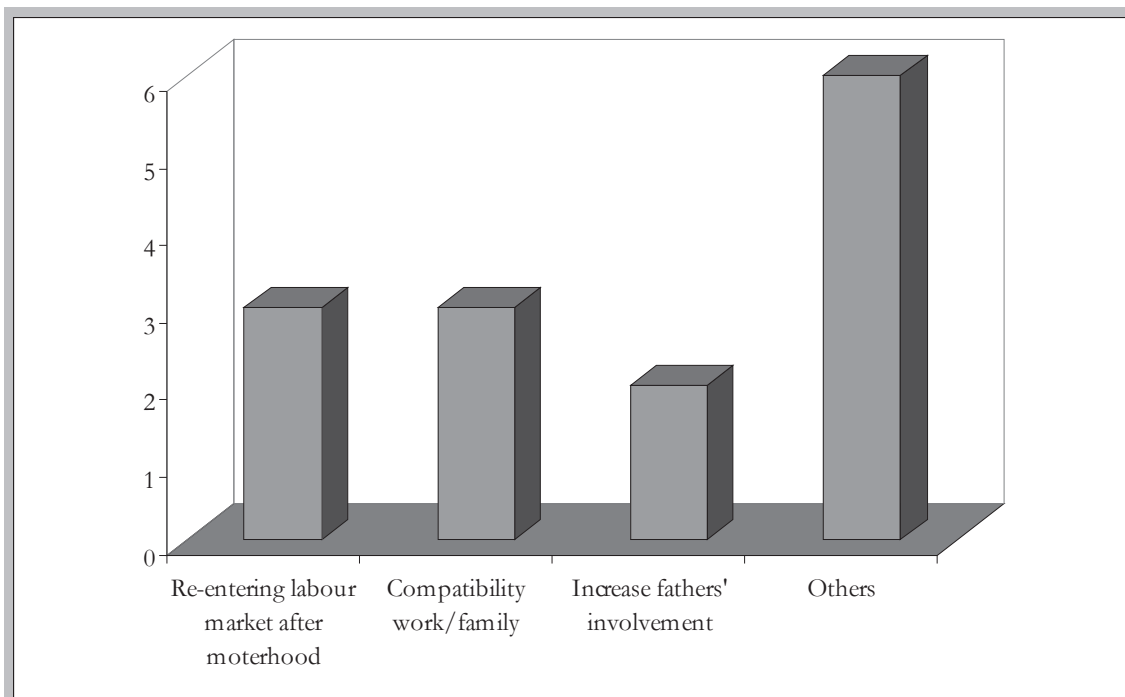

Three countries dropped the need for a more friendly work environment and work regulations both making more easy to return to work for mothers (Czech Republic and Cyprus) and improving parental leave (Slovenia). The case of Slovenia is a particular one because the need of improving parental leave was not consider by the panellists due to the satisfactory current regulations. The possibility of encouraging fathers to be more cooperative was eliminated by Austrian and Swiss panellists.

More interesting are the policy objectives included in the category “Others” which are so country-specific that cannot be grouped in a different way. Flemish panellists have eliminated during the fieldwork the possibility of realizing a better work and family reconciliation through an increase of freedom of choice of men and women in running the family and sharing household tasks; the wish for a family-friendly environment by the year 2030 was dropped out by Lithuanian panellists (while the need to develop a society promoting a balance between employment and family life has been included in the final scenario). The most specific policy objectives concerning the improvement of pre-school childcare services (Slovenia), the promotion of gender mainstreaming (Czech Republic and Switzerland) have not been considered as a priorities by the panellists in the related countries. Finally, in Italy the very traditional view of sustaining women who want to be only wives and mothers through specific measures has been rejected by the Italian panel.

4.3 Changing male and female roles

Changing gender roles is a big challenge for the year 2030. In fact 11 countries have this theme among those which arrived to the final scenarios. The desire to change existing gender roles was present in the questionnaire of all the countries: only Finland and Slovenia lost this theme during the fieldwork, all the other countries maintained at least one policy objective until the very end.

Grouping the policy objectives which did not reach consensus among the panels into categories, we obtained the distribution shown in Graph 4.3.

Graph 4.3: Rejected categories of the “changing gender roles” policy objective by number of countries

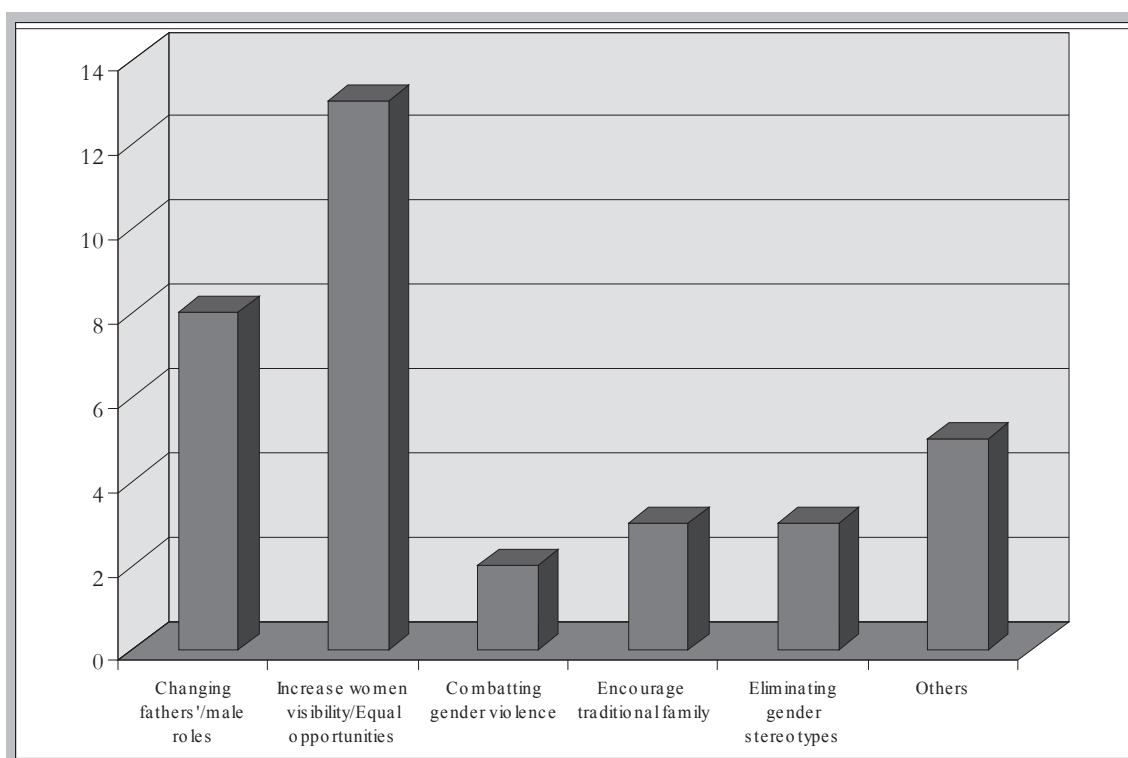

The need for gender mainstreaming, equal opportunities between men and women and increasing the number of working women in the highest levels of the hierarchical ladder is a policy objective which did not reach consensus inside the panels in B-Flanders, Cyprus, Finland, Germany, Lithuania, Slovenia, Romania and Italy. It may well be the case that in some countries such as Finland this is no longer considered a social goal to be achieved through new policy measures, while in other countries this may be considered a non priority issue as compared to other goals.

Seven countries (Austria, B-Flanders, Cyprus, Estonia Finland, Italy and Poland) rejected as policy priority for 2030 the idea of changing male roles. Three countries (Lithuania, The Netherlands and Switzerland) have also dropped the idea of

removing gender stereotypes though similar policy objectives have arrived to the very end scenarios.

In two countries, Finland and Lithuania, the possibility of changing gender roles through the elimination of gender violence and abuse has been dropped at a certain stage of the fieldwork. Germany, Italy and Slovenia did not agree to set as a priority for 2030 the possibility of encouraging and sustaining the traditional family with the man as breadwinner and the woman as housewife.

To complete the picture, in Cyprus and Czech Republic, no agreement has been reached on the idea of increasing the number of mothers re-entering the labour market after childbearing. The possibility of changing gender roles through better conditions for parents to reconcile job and family was not considered as priority for 2030 in Lithuania. The need of ensuring equal treatment of men and women in education systems as well as of the two gender in the old age have been dropped in Estonia.

As a general comment, we may say that the idea that men and fathers can change their behaviour and become more actively involved in family organisation and childrearing does not seem to be an important issue for the political agenda of the year 2030.

4.4 Active Ageing

Active ageing is an issue that appears very often in the policy recommendations and documents at EU level. 11 countries included this issue among the policy priorities for 2030 though with very different meanings and perspectives. Four countries (B-Flanders, Cyprus, Germany and Hungary) included this issue in their national questionnaires but it has not reached the necessary consensus.

In eleven countries some of the related policy objectives have been dropped during the fieldwork. The analysis by categories of these policy objectives is shown in graph 4.4.

In Czech Republic, Italy, Lithuania, Poland, Slovenia and Romania the need for prolonging the working life of people has not been chosen by the panellists as relevant policy objective for 2030; in Czech Republic, Cyprus, Germany, Lithuania and Switzerland the panellists did not select the idea of improving social integration of the elderly; Finland, Italy, Lithuania and Romania did not approve policies which consider the elderly as a social resource. Also the improvement of social and health services concerning old age has not been considered a priority for 2030 in Czech Republic, Germany and Lithuania.

In the category “Others” we find five countries which have eliminated specific measures concerning active ageing. In B-Flanders and Switzerland the panellists discarded the possibility of integrating older women in the society; in Lithuania the target of combating poverty among the elderly has not been considered a priority; the Italian panellists did not chose the policy objective of making it easier for the elderly to

travel inside Europe; the Swiss panellists were not in favour of the institutionalisation of life long learning and the political participation of the elderly.

Graph 4.4: Rejected categories of the “active ageing” policy objectives by number of countries

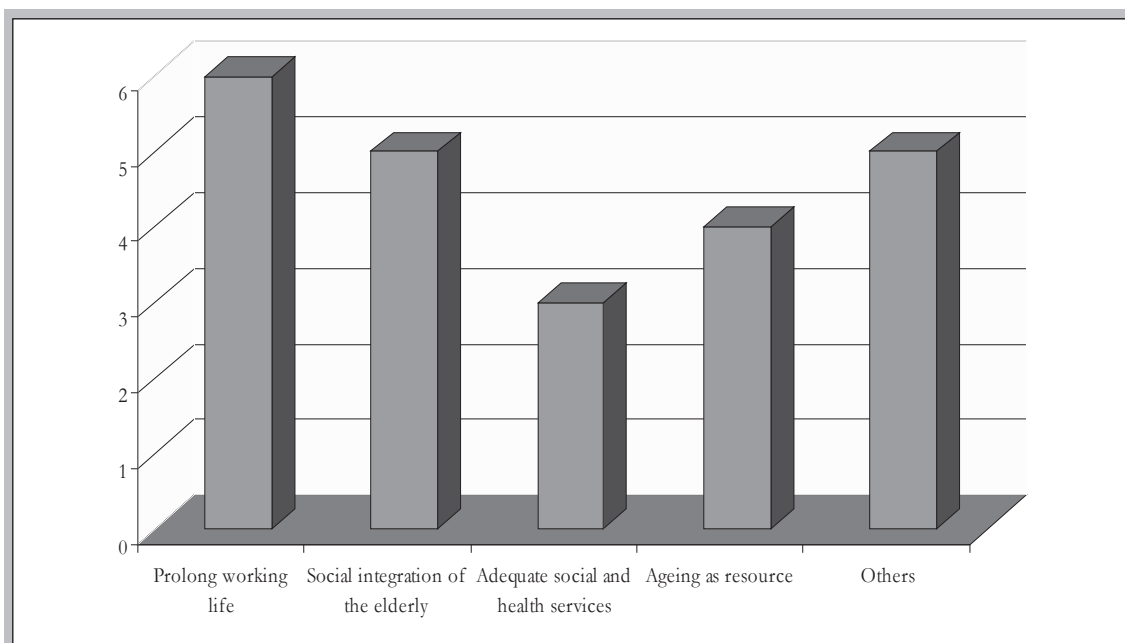

4.5 Child-friendly policies

The issue of child-friendly policies is relevant to design future scenarios where families are better supported by the State in their role as caregivers and children may live in an environment which guarantees them an improved well-being. Five countries (Czech Republic, Estonia, Italy, Lithuania and Switzerland) kept the issue in their final scenarios; four countries (Finland, Germany, Romania and Slovenia) included the issue in their questionnaire but it was dropped during the fieldwork; three countries (Italy, Lithuania and Switzerland) had the issue both in the final scenarios and as a dropped policy objective.

The child-friendly policy objectives aim at two different target groups: the families with children and the children themselves. The support to families takes different perspectives: families with children should have adequate housing conditions, the poverty of large families should be alleviated, costs of education should be eliminated or decreased and family support in general should be promoted. From the point of view of children, it is relevant for their well-being that they are treated in an equitable way - independent of the type of family where they grow up - and they are entitled to adequate caring and leisure time (Graph 4.5).

Graph 4.5: Rejected categories of the “child-friendly policies” policy objectives by number of countries

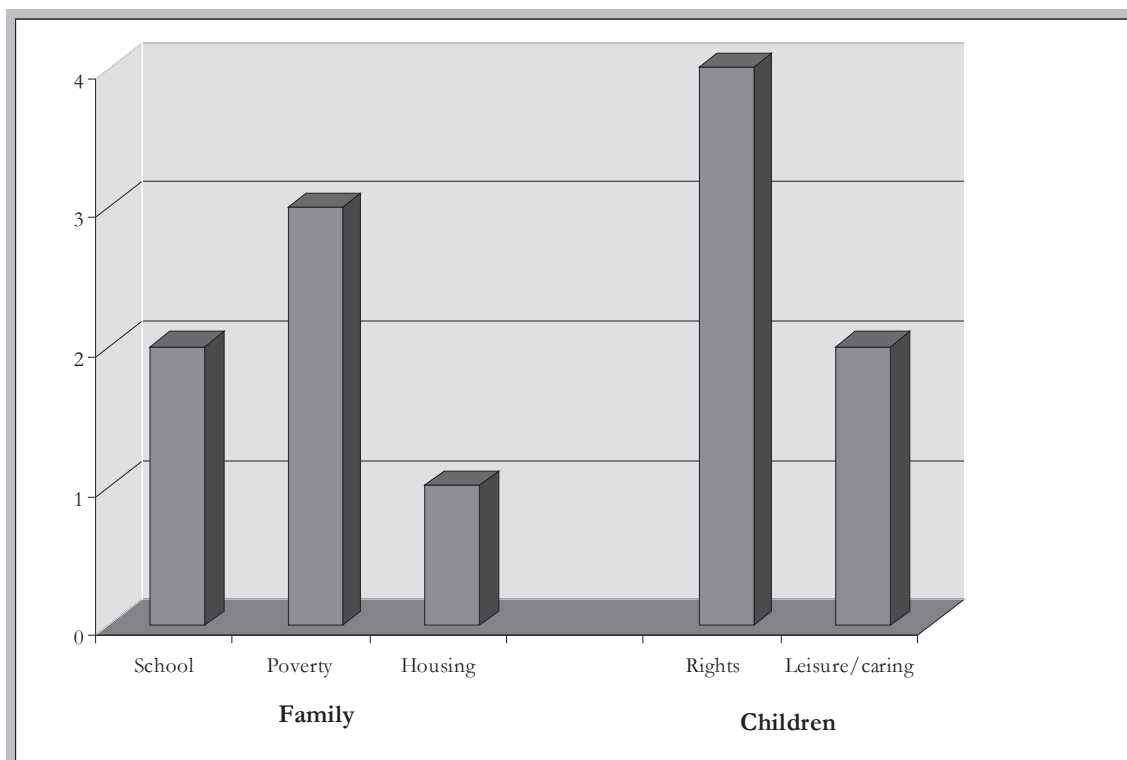

Children are entitled to rights though these rights are often overlooked by adults. In the Delphi study, Germany, Italy, Lithuania and Romania had included in their questionnaires policy objectives concerning the promotion and protection of basic children rights, such as the right to be treated equally independent of their family, the right to be cared for also by their fathers and the right to adequate leisure time. In none of these countries has this perspective reached the necessary consensus of the panellists.

Poverty is another important issue deeply affecting the children’s well-being. Germany, Lithuania and Slovenia included this issue: in Germany and Slovenia the policy objective was focussed on large families while in Lithuania it was more general.

To be noted that among these three countries only Lithuania kept the issue of child-friendly policies until the very end of the Delphi through policy objectives aimed at decreasing the costs of education and supporting children of disadvantaged families which entered the final Lithuanian scenarios.

As a final comment, we feel that the issue of introducing child-friendly policies was not really perceived as important among the participating countries. Only a limited number of countries included the issue in their questionnaire and what is even more important, only a small fraction of them consider children and their well-being a relevant policy priority to be attained by 2030 (See Annex B).

4.6 Sustainable pension systems

The issue of a sustainable pension system has become a very hot topic on the agenda of European policy-makers due to the current demographic development and the need for reducing public expenditure.

As a result, all the countries included one or more policy objectives focussed on the topic. It is thus relevant to highlight which political measures are considered as priorities for 2030 by the panellists and which have been eliminated during the fieldwork. Nine countries (Austria, B-Flanders, Finland, Germany, Lithuania, The Netherlands, Slovenia, Romania and Switzerland) dropped out some of the policy objectives concerning pension system sustainability because they did not achieve consensus among the panellists.

Non priority matters under the topic of pension system sustainability may be grouped in three broad categories: privatisation/individualisation of pension systems, adaptation of pension systems to current demographic trends and encouragement to the elderly to remain in the labour market (Graph 4.6).

Graph 4.6: Rejected categories of the “sustainability of pension systems” policy objectives by number of countries

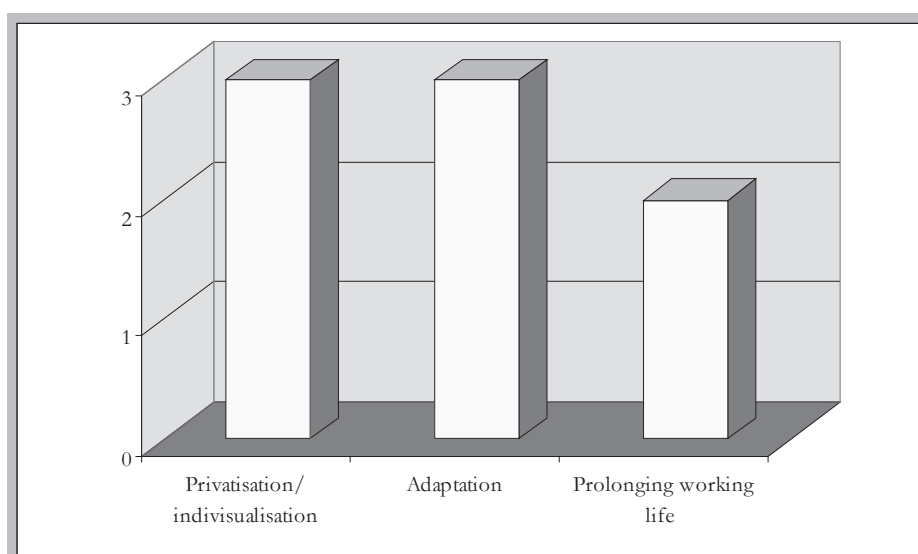

The goal of reaching the sustainability of pension systems through a privatisation of the system itself and/or increasing the personal responsibility of individuals in building up their economic security in old age was dropped in four countries, namely B-Flanders, Finland, The Netherlands and Romania.

Also the need for adapting the retirement schemes to make them adequate to the new demographic structure of the country did not reach consensus in three countries, namely Lithuania, Germany and Slovenia. To be noted that similar policy objectives aiming at re-adjusting the pension system in light of demographic changes

have reached the final scenarios in Germany and Slovenia. This means that the issue was considered so relevant for the policy agenda of 2030 that more than one policy objective concerning this theme have been included in the national questionnaires (see Annex B) and the panellists could select those policies they really felt adequate to solve the problem and more close to their wishes for the future.

Switzerland, B-Flanders and Poland also dropped the possibility of prolonging working life to make pension systems sustainable. Swiss panellists very clearly favour flexible retirement schemes; Flemish ones wish to avoid the possibility of early retirement. In Poland this issue appears in the final scenarios with different nuances.

5. Policy priorities in a comparative perspective

This section of the comparative study aims at highlighting those policy objectives that - in each one of the countries addressed by our policy-Delphi - have obtained the highest frequency with regard to the three issues investigated by our research, namely ageing, gender roles and family and fertility. We asked the focal points to highlight all the Policy Objectives which obtained the highest frequency of selection for each of the three issues

The comparative analysis of the priorities at national level will start by describing firstly the trends pertaining the ageing component, subsequently those regarding gender roles and lastly those in the area of family and fertility.

We will also present an analysis across the three issues highlighting where links exist between the three investigated areas.

Within the ageing component there are two main desires that our panellists in each European country wish to see realised by 2030. The first has a more economic viewpoint, viewing the pension as the financial means guaranteeing the elderly's economic self-sustainability and comprises policy objectives such as:

- Ensure legal pension
- To improve the economic living conditions of the elderly
- The guarantee of the retirement provision
- Adapting the pension system to socio-demographic change

The second goal pertains to improvements in the quality of life of the elderly. Some of the policy objectives that the panellists wish to see attained by 2030 are:

- to improve the quality of life of the elderly
- to promote positive policies and actions which support the general position of the elderly in the society
- to support intergenerational solidarity
- to promote health and self-sufficiency of the elderly

The figures below provide a clear synthesis on the basis of which a political agenda could be designed in order to guarantee both the financial self-sustainability and the quality of life of the elderly in the countries addressed by our study (Graph 5.1).

Graph 5.1: Policy priorities concerning ageing by number of countries

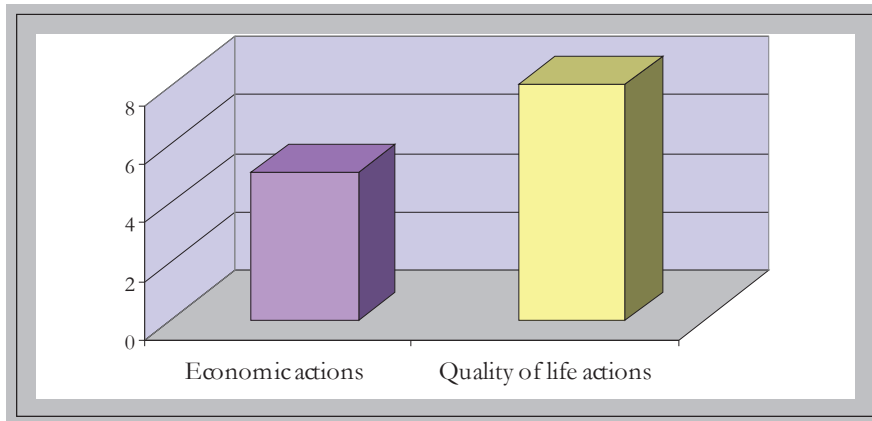

With regard to the gender role component of our study, once again we can highlight two main trends summarising the results to be attained by 2030, namely: to sustain work and family reconciliation, and to rethink the role of women in our societies and subsequently those of the men. Male and female roles are tightly intertwined and cannot be part of a “*separatist*” way of thinking and acting. Our panellists mainly focus their attention on actions benefiting women’s roles as obviously women form the gender group that are most discriminated against and who are the direct target of a hidden gender apartheid affecting our society, though a new social packing order will affect the role of men as well.

The countries forming part of our study have indicated the following as goals to be reached by 2030 in order to modify the current position of women in our societies:

- the increase of earning in women specific jobs;
- the reduction of double burden for mothers
- the enhancement of women’s presence in decision making roles
- the promotion of equality in working-life
- and others.

The figure below provides a synthesis of the relative positions of policy objective regarding gender roles. A comparative analysis in the countries taking part in our research highlights that by 2030 women’s roles will change, mainly from the perspective of a better balance between work and other areas of life (Graph 5.2).

Graph 5.2: Policy priorities concerning gender roles by number of countries

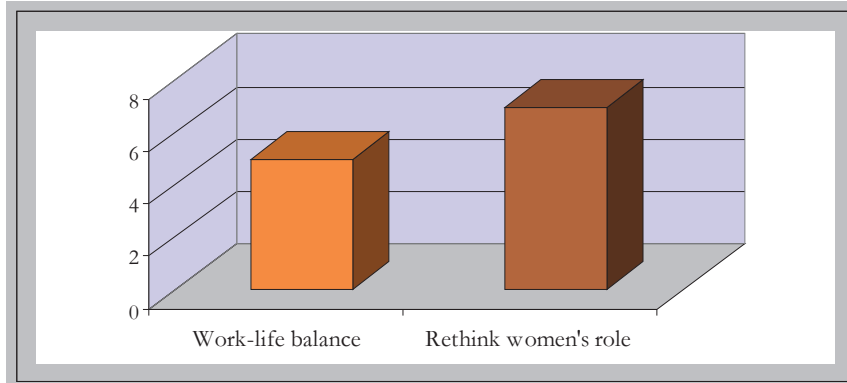

Last but not least the comparative analysis on national priorities in the field of family and fertility highlights that, by 2030, families in the various European countries addressed by our study should benefit from a better work and family reconciliation and from an improvement in their quality of life. The latter wish can be attained via the pursuit of a number of policy objectives, namely:

- the development of stable conditions which support the establishment and sustainability of families,
- the establishment of child/family friendly environments within society
- the improvement of assistance for young families
- the reduction in the number of people living under the poverty threshold.

The figure below (Graph 5.3) highlights and synthesises the changes that are sought when dealing with policies affecting family and fertility in the various European countries under examination. In the context of improving the standard of living for families, it is fundamental to promote the idea of balancing work and other aspects of life (the “work and family reconciliation”).

Graph 5.3: Policy priorities concerning family and fertility by number of countries

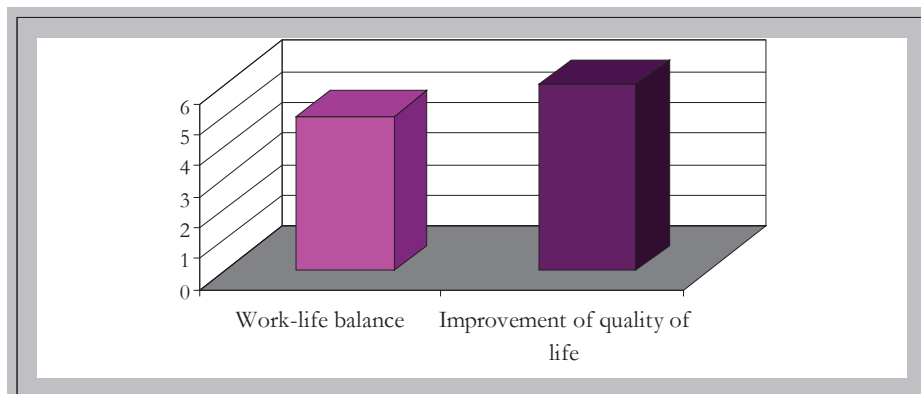

Overall, the comparative analysis of the most wished policy objectives highlights that by 2030 Europe should have attained a program integrating a number of intertwined policies affecting the life of European citizens. There is a *new deal* emerging from the comparative analysis of national priorities.

The idea that our lives should be conducted on a work and family reconciliation philosophy from now through the future. When dealing with family and fertility this should be integrated with policies sustaining the improvement of the quality of life of all family components no matter their age, gender or health condition.

The idea of gender only remains for biological reasons, men and women are different but should have the same opportunities, both outside and within their families. With regard to the gender role issue infact the future should be designed once again departing from building work and family reconciliation and accompanying this intervention with a clear focus on equal opportunity which implies rethinking men and women social roles.

Last but not least comes the ageing perspective which naturally derives from having conducted a more balanced life in the previous stages of our existence. Ageing is no longer a phase of life; it is simply the natural progression of an healthy and balanced conduct attained in the previous year. Older age will be seen as a “stage” in life within which we still enjoy our being through a consistent health status and financial security, but also via a stronger intergenerational dialogue.

6. Comparing SWOT Analysis

Swot Analysis is a method that allows to use existing and acquired knowledge to comment on the characteristics of scenarios and to complete an analysis, drawing up a framework upon which strategies can be designed. In particular, the SWOT analysis allows the panellists (and us) to audit the selected scenario stressing the positive and negative effects related to its implementation in a imagined future.

In comparing the results among countries we are going to use the comparative perspective adopted in this report that is to highlight the most quoted issues to create a common list of topics selected by each section of the analysis (i.e the Strengths and Weaknesses of each national scenario, as well as the Opportunities and Threats).

The majority of the comments and of the evaluations gathered in each report are related to the six themes/problems identified in Chapter 3 as the most important in the agenda of European policy makers.

6.1 Points of Strength

In the list of the resources and points of strength that are seen inside the scenarios indicated by the panellists of each country is emerging the positive approach to the imagined future used in this Policy Delphi (Table 6.1).

In fact we have here a quite large convergence on different issues related to the general environment that should go with the realization of the scenario. On the top of the rank we found two very 'idealistic' issues expressing a need and a hope for justice and social cooperation like solidarity and gender equity. A different modulation of this factors is found among countries, regarding solidarity: intergenerational aspects are stressed in the Czech Republic, Estonia, Hungary and Slovenia, while the inclusion of all groups of the society is highlighted by Italy, Lithuania and the Netherlands. In Germany this element is expected as a general society orientation. The second expectation as effect of implementation of the dreamed scenario in seven countries is gender equality. In Italy, Slovenia, Germany and Switzerland this is considered mostly from the point of view of the family: parents sharing the task of childrearing and housework, a realized balance between maternal and parental leave, realized father's responsibility. The promotion of women's role in society, equal opportunity in the labour market and a fair system of salary are also additional ways to indicate the positive effects of realized gender equity in a desired society.

Strictly linked to gender issues is the theme of flexibility considered in many countries (Finland, Italy, The Netherlands, Poland, Slovenia) as the best way to combine work and family life, while in Switzerland the focus is on a flexible retirement scheme.

We have already seen how *raising fertility* is an issue considered as policy priority (see 3.1) in a number of countries, which is why this aspect is also indicated as a positive goal (Cyprus, Austria, Estonia, Hungary, Poland).

Another aspect that confirm the strong idealistic approach of the panellists in many countries is the theme of *freedom*, meant both as choice for people to have the kind of family they desire (Czech Republic and Poland), and in a broader sense, as the possibility of having more freedom and autonomy for all citizens (Germany, The Netherlands).

Table.6 1 - STRENGTH ISSUES

ISSUES	Country	Main causes determining scenario strength at country level
Spread of Solidarity	Czech Estonia Hungary Italy Lithuania Netherlands Germany Slovenia	Intergenerational Intergenerational Intergenerational Social Cohesion Inclusion All Society Inclusion All Society General Society Orientation Intergenerational
Gender equity	Austria Cyprus Finland Italy Slovenia Germany Switzerland	Paid/Unpaid Work Parents Parents Parents Fathers
Introducing Flexibility	Finland Italy Netherlands Poland Slovenia Switzerland	W&F W&F Leave System W&F Reconciliation Time
Raising fertility	Cyprus Austria Estonia Hungary Poland	 Slow Ageing
Freedom	Czech Germany Netherlands Poland	All Form Of Family All People Choice All People Choice All Form Of Family
Appreciating Family	Czech Italy Poland	
Changing values and attitudes	Cyprus Lithuania Switzerland	
Supporting pension system	Austria B-Flanders Germany	Less On Labour Stabilising
Quality of life (improvement)	Lithuania Italy Poland	By Technologies
Long term policies	Cyprus Germany	

In a coherent view with previous points and policy priorities, some countries (namely the Czech Republic, Italy and Poland) forecast a growing social *appreciation of family values*, while others (Cyprus, Lithuania and Switzerland) wish and expect a more general and deeper process of *changing values and attitudes* regarding cultural and social mentality, particularly stressing on gender roles.

Another important positive effect indicated by three countries and also related to policy priorities (see 3.1) is the aim of creating a society where the *pension system*

is supported by the economic organization of society both via a lesser dependence on labour (B- Flanders) and by stabilising the retirement scheme (Germany).

Finally an overall *improvement of the quality of life* is a result envisaged by a number of countries (Lithuania, Italy and Poland), only Italy stress on the role of the widespread use of new technologies.

It is to be noted that two countries (Cyprus and Germany) highlighted the importance of designing long term policies, abandoning the narrow view of implanting short term actions aimed at solving problems instead of changing the future.

6.2 Points of weakness

The second component of the SWOT analysis looks at the scenario's weaknesses (Table 6.2). The weaknesses highlight the characteristics of the scenarios that are thought potentially to hinder the achievement of the policy objectives within the six areas selected to draft the comparative study, an increase in the number of births, an improvement in the work and family reconciliation of men and women, changing male and female roles, active ageing, child friendly policies, sustainability of pension systems.

The comparative reading of the various SWOT analysis produced at a national level highlights that the above mentioned policy objectives and their related key success factors present some common weak points that can be grouped under four major headings, namely:

- The implementation of the scenario is difficult as its content is utopistic
- The implementation of the scenario is difficult as its policy objectives are incompatible
- The implementation of the scenario is difficult due to the existing financial problems that might hinder its achievement
- The implementation of the scenario is difficult due to the excessive role of the State

The weaknesses vary depending on the countries, though representing a common ground for quite the majority of them. The comparative reading of the first one of the four weaknesses shows that eight countries believe their scenarios, with regard again to the six themes part of the comparative analysis, to be *idealistic*. These countries are Estonia, Germany, Poland, Romania, Slovenia, Switzerland and the Czech Republic.

The value attributed to idealistic scenarios varies from country to country. In Slovenia, for example, this equates with the risk of superficiality in implementing some of the measures, the Swiss panellists believe somehow that some of the measures are not concrete, the Czechs highlight that the scenarios are lacking in terms of practical tools to achieve the policy objectives.

The second weakness pertains to the conflicts and incompatibilities within the scenarios. Six countries believe this to be a relevant characteristic of the scenarios,

namely: Hungary, Germany, Italy, Poland, The Czech Republic and Germany. In Germany we have found a general feeling of distrust towards the future and lack in believing that the required political consensus might be obtained to achieve the policy objectives and implement the related measures. In Hungary, Poland and Italy the conflicts and incompatibilities pertain to the evolvement of gender roles and the family requirements. It's quite interesting to note that when talking about gender roles it's a common belief that a different participation of women to the establishment of our societies will hinder family development and does not contemplate a parallel and required revision of men role both in our societies and within family, belief that generate, an obvious conflict.

Table 6.2. WEAKNESSES

WEAKNESSES	Country	Main causes determining scenario weakness at country level
<i>Too much idealism - Utopia</i>	Estonia Germany Poland Romania Slovenia Switzerland Czech	Superficial approach in implementing measures Measures not concrete Lack of practical tools
<i>Conflicts and incompatibilities</i>	Estonia Hungary Germany Italy Poland Czech Germany	Ageing Family, gender Political consensus Gender Family /female employment Individualism vs cooperation Distrust in future
<i>Financial problems</i>	Austria Estonia Lithuania Poland Romania Slovenia B-Flanders	For pensions
<i>Role of the State and Private sector</i>	Poland Switzerland Netherlands Cyprus	Too much state control Unclear , inclusion of employer's point of view Unclear distribution of tasks

The third weakness has a financial dimension. Austria, B-Flanders, Estonia, Lithuania, Poland, Romania and Slovenia believe that the achievement of the objectives will be slowed down by the financial constraints and the lack of financial resources existing in our societies. In B-Flanders there is additionally a common feeling that pensions will contribute to generate financial constraints.

Last but not least, scenarios will be constrained into the excessive role that the State and the Private sector plays in the development of our societies. This is the belief of Switzerland, Poland, The Netherlands and Cyprus.

6.3 Opportunities

Among the possible points for sustaining the scenario from outside, six countries (Austria, Germany, Italy, Lithuania, Romania and Switzerland) highlighted that the scenario will enforce *social cohesion and integration* between the various social groups (Table 6.3). As a result, this future society, being more integrated and less hindered by social conflicts, will naturally support the implementation of the desired policy actions. As a further opportunity reinforcing social cohesion, Cyprus, Estonia, Finland, the Netherlands and Slovenia favour the *improvement in attitudes towards the elderly* that will act as a cultural catalyst to sustain the scenario. A well integrated and cohesive society will constitute the best possible environment for couples who wish to have children. This is the reason why Cyprus, Czech Republic, Estonia, Finland, Hungary, Slovenia and Switzerland perceive in the realization of a *child oriented society* as foreseen for the scenario an additional opportunity for making sustainable the desired society.

It goes without say that the *economic growth* is a necessary factor for achieving the political goals by 2030. Last but not least three countries (Cyprus, Czech republic and Romania) consider a deep rooted role of NGOs as supporting and accompanying factor of the scenario implementation.

Table 6.3 - OPPORTUNITIES

OPPORTUNITIES	Countries
<i>Social cooperation</i>	Austria, Italy, Germany, Lithuania, Romania, Switzerland
<i>Economic growth</i>	B-Flanders, Czech, Hungary, Lithuania, Romania
<i>Improvement of attitude towards elderly</i>	Cyprus, Estonia, Finland, Netherlands, Slovenia
<i>A child oriented society</i>	Cyprus, Czech, Finland, Hungary (adoption easier), Estonia, Finland, Slovenia, Switzerland
<i>A wider role for NGO's</i>	Cyprus, Czech, Romania

6.4 Threats

As expected, the policy makers themselves are considered one of the major threats to the realization of the scenario because of their slight interest in policies which go beyond their mandate (Table 6.4). Very often, in fact, when the government changes, the political goals change accordingly. This is the reason why B- Flanders, Germany, Lithuania, Netherlands and Poland indicate *political instability* as a possible threat to the scenario implementation and Poland, Romania Slovenia and Switzerland identified *political distrust* as a risk to the realisation of the imagined future society.

Additional risk factors lay on the economic side: *lack of funding* and *international economic instability* may make the scenario unsustainable.

Social systems are characterised by a deep inertia which makes changes difficult to achieve and slow to attain. This is a warning very clearly expressed by B-

Flanders, Czech republic, Hungary, Germany, Italy and Slovenia. More specifically *difficulties in changing values and attitudes* of common people have been highlighted by Czech Republic, Germany, Lithuania and Slovenia, while the diffusion of *materialistic, individualistic and egoistic values* and behaviour are considered a threat in B-Flanders, Germany, Italy, Lithuania, Netherlands, Poland and Slovenia.

Surprisingly the *enlargement of the EU* is perceived as a threat by Lithuania, Poland and Romania which are worried that the new European assessment will result in a “double standard for newcomers and old members”. The same worry is perceived in the Netherlands while Italy stressed the danger of a passive role of EU and the risk of a double standard between Northern and Southern countries.

Table 6.4. - THREATS

THREATS	Country	Main causes determining scenario threats at country level
<i>Materialism, individualism, egoism</i>	B-Flanders, Germany, Italy, Lithuania, Netherlands, Poland, Slovenia	
<i>System inertia</i>	B-Flanders, Czech, Hungary, Germany, Italy, Slovenia	
<i>Lack of funding</i>	Hungary, Germany, Poland, Romania, Estonia	
<i>Economic crisis, instability</i>	Czech, Italy, Netherlands, Hungary, Switzerland	
<i>Political instability</i>	B-Flanders, Germany, Lithuania, Netherlands, Poland	
<i>Political distrust</i>	Poland, Romania, Slovenia, Switzerland	
<i>Difficulties in changing values and attitudes EU role</i>	Czech, Germany, Lithuania, Slovenia Italy Lithuania Romania Netherlands Poland	Passive role Double standard for newcomers and old members Enlargement Differences between countries Enlargement

7. Desired future population trends

During the interviews, the panellists were asked to express their desires and dreams regarding a number of population trends, on the basis of historical developments, through their perceptions and intuitions. Each of the participating countries autonomously identified which were the issues to be included in the study according to their social relevance; for this reason the number and the type of trends considered in the 15 different countries are diverse. Trends were submitted to the panellists' attention in a graphic format; their number varies from 5 to 18. Some of them refer to classic demographic indicators (i.e. number of inhabitants, number of migrants, percentage of childless women), others concern labour force issues (i.e. unemployment, number of retired people, percentage of part-timers, working women,

etc.) while others refer to macro economic indicators (i.e. expenditures for family benefits, premium for compulsory health insurance, etc.).

Amongst all the issues considered, there are some common to several countries. We will analyse the results obtained at the end of the fourth round, highlighting similarities and dissimilarities of these common trends. In particular, we will analyse which trends reached a consensus during the process, i.e., if the wishes and desires of the panellists converge from the first to the last round to a closer range or which trends remained with the two extremes of the interval open¹¹. In addition we will see if a common view on the direction of future population developments exists in Europe.

As a rule, the panellists were encouraged to draw each graph according to their wishes for the future, without worrying about realistic or scholarly-driven trends. In general, we obtain different reactions. Some of the panellists were curious, had positive feelings and were interested with the Delphi exercise, while some others criticised the approach and had negative reactions or expressed difficulties with an idealised approach.

The indicators common to at least 8 countries pertain to different areas: population and its age structure (% of the elderly); reproductive behaviour (TFT, out-of-wedlock births, mean age at the first motherhood); marriage rate and marital instability; and female labour force participation (Graph 7.1). Not all the common trends were measured by means of exactly the same indicator, but the meaning was the same and we could analyse them together. For instance we have both the crude marriage rate and the total first marriage rate, that gave similar information about the future propensity for marriage in a population. The same is for the percentage of elderly for which some countries consider population aged more than 60 years while others consider 65 as the lower age limit.

¹¹ During the first interview the trends are submitted to panellists' attention in a graphic format and the panellists are asked to design the desired future level by 2030. After completing the 1 round's interviews new graphs were prepared and resubmitted during the 2nd interview. Each graph has the shape of a scissor, having as extreme of the scissor the lower and the higher level indicated by the panellists. During the second interview the panellists are asked to re-design once again desired future population trends within the scissor and the same procedure for preparing the graphs for the 3rd round has been applied as described before. At the end of the fieldwork each graph has a more or less ample scissor. The scissor/interval/range might stay the same or reduce and might be ample or narrow, the reduction of the space between the scissor indicates a consensus reached by the panel.

Graph 7.1 Number of countries by type of trend

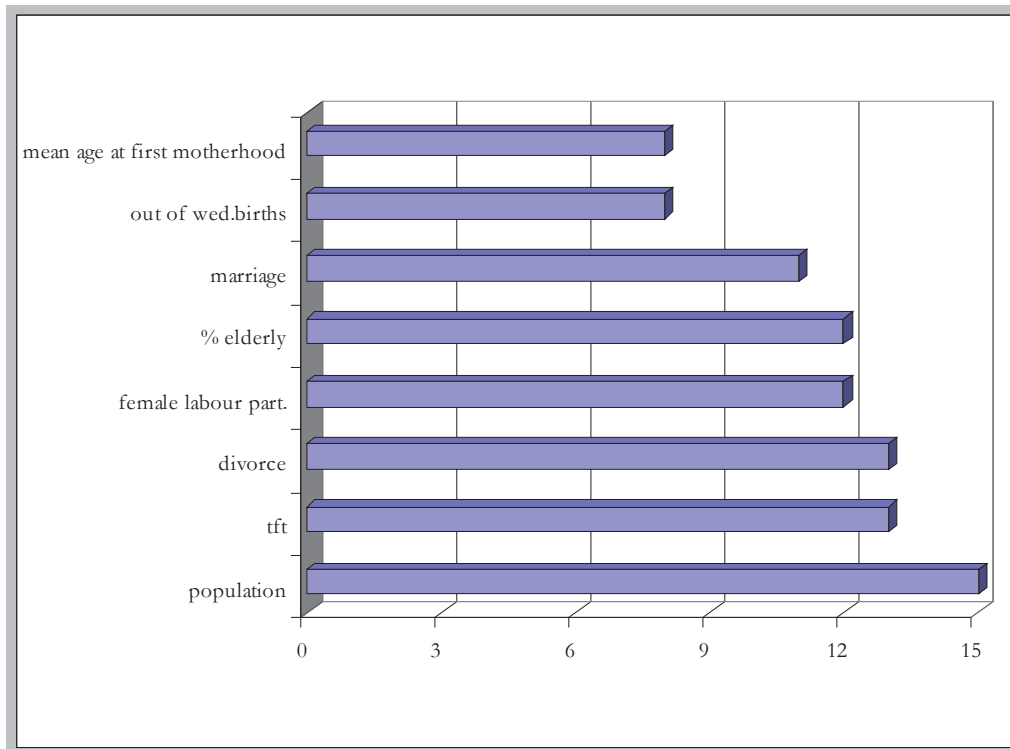

7.1 The consensus

Graph 7.2 shows how many countries converge towards a consensus (which is indicated by a tight scissors) on the various trends while table 7.1 highlights in which round the consensus have been reached.

The trend on the number of inhabitants has been selected in all the 15 countries. Only three countries (Estonia, Italy and Poland) did not reach consensus on the desired future population in 2030, two of them arrive to a tight scissor during the second round and 7 at the third round. Therefore, it seems that there is a well defined opinion on the desired population and, as we will see in the next section, panellists expressed a significant agreement on the direction of future population development.

The pattern observed concerning future marriage trends is quite similar to the previous one: only 3 out of 11 countries did not reach consensus and 5 out of 11 stopped presenting the graph before the final interview, having already obtain a tight range.

Table 7.1 Number of countries reaching consensus on future population trend by round and type of trend

Trends	Round 2	Round 3	Round 4
1.Population (N)	2	7	3
2. Marriage rate	1	4	3
3.Total Fertility Rate	4	2	3
4.Labour force participation of women	1	5	2
5.Out-of wedlock births (%)	0	4	1
6.Quota of elderly	2	3	2
7.Total Divorce rate	1	3	3
8.Mean age of women at 1st birth	0	2	1

Graph 7.2 Countries where consensus have been reached by type of trend (% out of the countries having the same trend)

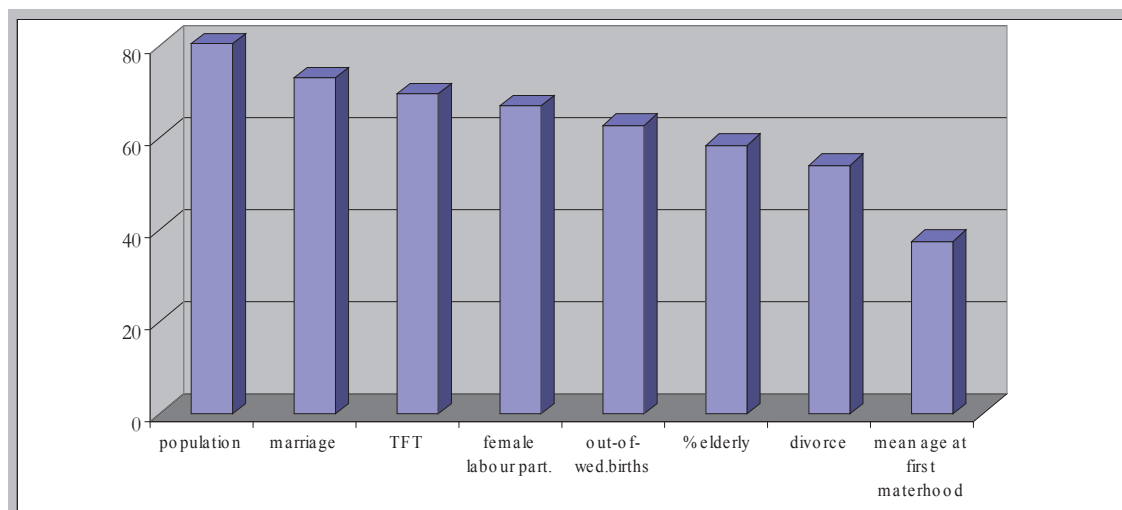

The wishes expressed on future fertility, out of wedlock births, and women's labour participation have not reached consensus in approximately 1 country out of 3. In the countries where the consensus has been obtained, narrow scissiors have been reached during the intermediate rounds, showing a discrete agreement among panellists on what should be the reproductive behaviour and the role of women in the labour market in the future.

The goals for the future development in divorce, the presence of elderly and age at the first motherhood appear to be the most controversial demographic issues: 40% or more of the countries, having included these trends, could not arrive to a consensus and the countries where an agreement have been reached, a tight scissor have been frequently obtained in the last round.

7.2 Which developments in population trends?

7.2.1 Population

The majority of the experts reached consensus regarding the number of inhabitants in their own countries by 2030. Looking at the national graphs it emerges that the majority of countries expressed the desire to see the population increasing in the future years or maintained the number of inhabitants at the current level.

Analysing countries who wish an increase in population it is worth noting that the dreams expressed by the panellists are mainly in favour of a slight increase (Germany, Lithuania, Poland, Slovenia) than of a more considerable rate, as was desired in one country (Italy). The same number of countries (five) wished for “zero population growth” and wanted the number of inhabitants to be kept stable at around the actual level (B-Flanders, Czech Rep., The Netherlands, Romania, Switzerland). The reasoning behind this position has to do with the sustainability of the social and economic structure and the guarantee of the financing of the health and pension system. For instance, as highlighted by the Austrian panellists, an increase in population may well be related to the economic growth of the country. Only two countries expressed the desire to see their population decreasing by 2030, both through a moderate (Hungary) or more considerable (Estonia) rate of reduction.

The general comment we can draw is that panellists’ auspices went towards minor changes in the number of population, in order to preserve the current societal organization, guarantee an high quality of life and a healthy environment, and not overburdened infrastructures, while responding to labour market needs, and solving budgetary problems and facing with public debts.

7.2.2 Fertility

Similarly the direction in fertility is towards an increase in the number of children. Whatever the indicator chosen by the countries, this is undoubtedly the development sought by our panellists. The reversal of the more recent trend appears in all the countries (with only 1 exception, Hungary) and here the magnitude of the increase is to be questioned. Austria, Germany, and Italy desires a range close to the replacement level while B-Flanders, Estonia, Poland and Switzerland dream a fertility that go from the current (or above) level to more than 2 children per woman. In an intermediate position appear Lithuania, The Netherlands, Romania and Slovenia these countries wish an increase in the number of birth compared to the current situation without reaching the levels historical recorded. As far as Slovenia is concerned, this may be caused by the panellists’ awareness of the fact that expecting an increase in births is unrealistic.

7.2.3 The presence of the elderly

Opinions about the presence of the elderly have been influenced by a diffuse awareness on what Europe can expect concerning demographic structure. Panellists are well informed about demographic developments and that the elderly - from a quantitative point of view - will increase their weight on the future society. For this reason many experts were not able to “wish” and reported what they knew or decided “to dream a realistic dream”, as Germany reported. Therefore the vast majority of the countries indicates an increase in the presence of elderly in their own society.

Only few panellists desired a decline or a stabilization in the percentages of elderly compared to the current one (Czech Republic, Cyprus, Estonia, Italy) while many indicated an higher value. Among the former it is interesting to note the comment from Cyprus, where some panellists claimed that they would like the aged population to constitute a smaller proportion of the total population. They explained that this preference was because of the problems usually faced by an economy in an ageing society. In particular, the participants stated that the prospect of an ageing population might have a depressing effect on the ability of the economy to generate adequate savings and investments, to ensure positive economic growth, and to continue rising levels of per capita income.

As it was claimed by the experts, the growing number of women entering the labour market, affects negatively the possibility of caring of the elderly inside the family and implies a decreasing responsibility towards the old family members. Consequently, this would in turn imply that public provisions for the care of a growing number of very old people have to be added to social expenditures and taxation will increase.

7.2.4 Marriage rate

Analysing the dreams on the development in marriages, 6 out of 11 countries show a willingness to see the marriage rates increase in the next 30 years: the majority of them agreed to position marriage rates in a narrow range (Germany, Hungary, Lithuania, Poland, Slovenia), while only Czech experts provided a more ample choice.

Switzerland, Romania, Estonia, Italy, and Austria expressed a less precise opinion on the future trends. Switzerland is showing a divergence among panellists ranging from a stabilization to a small increase in marriage rates; the other countries range from an increase in the number of marriages to a decrease. The divergence amongst panellists shown in some countries can be the result of a social controversy about the meaning of marriage, well-represented by the ideological/political positions of the panellists. Some panellists would like to attach high value to marriage for its religious meaning while others considered it less relevant because of the secularisation process taking place in the last decades. For this reason some countries showed a diffuse indifference to the issue.

7.2.5 Marital instability

Nuptiality and marital instability are obviously related. Few countries expressed the desire to see a stabilization in the number of marriage ending in a divorce, while the dream of an increase of divorce has definitely not been popular. About half of the countries desired a decrease in the separation/divorce rate and, according to the wishes of some panellists, marital instability should dropped to zero.

Even here it seems that the perceived meaning of marriage - and therefore of divorce - plays an important role in shaping wishes and desires for future trends. As highlighted in the Polish report, “some panellists argued that they would like the number of divorces to decrease but they would also like people to live in happy marriages. If it is not so, it is better to divorce“. On the other hand, experts coming from religious organizations stress the importance of making the access to divorce more difficult for the sake of the value of the marriage. The wish for a declining number of divorces has been also supported by the right/need for children to live with both parents.

7.2.6 Out-of-wedlock births

Wishes on the developments of the quota of births from unmarried couples appear very diverse in Europe. Amongst a total of 9 countries that submitted to the panellists the graph on the desired quota of out-of-wedlock births, 3 expressed the desire to see it increasing and 3 indicated a range that approximates the current level. In the remaining 3 countries the interval obtained at the end of the process remained very ample, with no clear indication on the future tendency.

In some cases this issue has not been considered relevant for future society, because nowadays there is no stigma associated with having children in or outside a marriage and children born from unmarried cohabitation have the same rights as those born to married couples. So it can be argued that the relevance of the phenomenon has partially shifted from the importance of the having children under whatever conditions to the necessity of guaranteeing an harmonious development of every children, also defining by law parents' responsibilities about their children.

7.2.7 The age at first motherhood

European women are waiting longer and longer to form their families, and the average age of a woman at first birth is going up. All the countries examining the future trend on the age at motherhood show a rise in the indicator, and the evaluations given by the panellists are quite diverging. In fact, in 3 countries out of 7 (B-Flanders, The Netherlands, and Slovenia) the wishes are towards a decrease in the age at the 1st birth, in 1 country only (Cyprus) the auspices are towards an increase while the

remaining countries indicate a more ample spectrum, with some panellists wishing the age of the mother at the first child to fall and others to rise.

The feeling behind these trends show the existence of two different prospects that have to do with the relationship between motherhood, working life, demographic worries and health considerations. As pointed out by Austria, some panellists wished an higher age at motherhood because this choice makes it easier for a woman to complete her education and to have a job, while others panellists desired a lower average age at birth because younger women are healthier and likely to have more children than older ones.

Another determinant of the fertility rate, which was strongly supported almost by all participants, is the double burden experienced by working mothers and specifically the constraints imposed on the ability of mothers to work and at the same time to care for her young children. As was indicated, population policies should be designed in such a way that they incorporate both the aims of raising fertility and that of raising the female educational attainment level as well as the female labour participation.

7.2.8 Women labour force participation

As indicated in many EU documents, one of the challenges Europe will face in the near future is the need to increase female labour-force participation. With some exceptions (i.e the Eastern countries) female participation has been rising in recent decades, and cross-country differences have narrowed, but they still remain important. Within the factors affecting female participation cultural attitudes play an important role and they are starting to change. An analysis of the countries' findings on the desired trend in female labour participation, indicate the tendency toward an increase in the number of working women in the vast majority of countries. Only Hungary showed a (moderate) decrease in female employment, that, according to the comments highlighted in the country synthetic report, is "currently extremely low" and record a dramatic drop since the '90s.

As we noted regarding future fertility trends, here is the magnitude of the increase and the speed of the development to be questioned. In some countries, like Austria, Germany, Italy, Lithuania we can note a substantial increase in working women by 2030, in others the desired increase is more moderate, or shows a more ample spectrum of alternatives but, even here, the results clearly sustain the idea that future European societies will see a growing number of women entering in the labour market.

8. Dream for Europe

8.1 The European Delphi

The Delphi study was designed to define national perspectives on social and population issues at the horizon of 2030. Because of its geographical aspect and the specificity of each national study, it was felt that a European dimension could complement the research. In this way, the overarching principle of the European Delphi stems from the necessity to give an overview of European trends and to define priorities from people working in a pan-European environment. Hence, panellists in charge of “dreaming” a future Europe, had to be working in a European environment.

This trans-national method did not come without difficulties. Challenges derived from the different scope and approach of the research methodology, compared to each national Delphi. The first problem was to define the geographical boundaries of Europe. Would we be talking about the European Union with 15 member states, as it still was at the moment of the panel’s definition, the enlarged Europe with 25 members, or about Europe as a geographical entity? A part of this ambiguity still remained in place after it had been decided to take into account a larger European Union, for it is difficult to predict what the EU will actually look like in 2030.

A second difficulty is the fact that debates at the European level tend to focus on a limited set of issues (the EU Constitution, enlargement, common defence and foreign policy), while completely ignoring others. Some matters of relevance to this study have not yet become of public interest at the supra-national level, probably because the decision-making process in such areas as population and society still resides at the national level.

However, these challenges did not hamper the conduction of a rigorous study, highlighting the flexibility of Delphi research methodology. They should not be apprehended as obstacles to a correct European Delphi, but as challenges to overcome and issues to be addressed in the future by policy-makers: if some perceptions and perspectives have been pointed out by most of our experts and common positions have emerged, should not these be considered as deserving more attention from the European institutions?

8.2 The panel

In accordance with the methodological approach, the panel was constituted with 15 experts, who either worked within European institutions (i.e. European Parliament, European Commission) or in NGOs related to EU developments. Of the 15 people 5 were women, and only 2 were not residing in B-Flanders. Unfortunately, one panellist dropped out after the second round.

The panel - which was set-up in each one of the fifteen countries - comprised a highly diverse set of experts, namely:

- Lobbies and pressure groups
- Journalists
- Church representatives, religious associations
- Academics
- EU Commission
- European Parliament
- European Regional Committee
- NGOs

Before the start of the fieldwork, a circular e-mail was sent to about 200 European experts in family and fertility, gender roles and population ageing. In this e-mail the experts were asked to highlight which they considered to be the most important policy objectives and key success factors concerning the three issues, with the aim of designing the questionnaire. Their answers were used to draft the questionnaire of the first round.

8.3 Demographic trends

The European Delphi study was divided into four major components. The first one, the population trends for Europe in 2030, aimed to define the demographic future of Europe through 7 indicators. For each one of the trend the panellists had to indicate an ideal evolution until 2030.

Overall, a majority of experts seemed to share a vision of Europe as a continent that needs to change its demographic pattern, as trends are regarded as somehow deteriorating. Several panellists puts forward the comparison with the United States, a younger and a growing country with a stronger population growth, higher fertility rates, and a higher participation of women in the working life.

In details, the panel clearly desires an increase in the European fertility rate compared to the actual level (1.8 to 2.3) and longer life expectancy at birth, ranging, between 80 and 87 years. It also wishes to see a sharp increase in female activity rates (between 58 to 81%, Graph 8.1) as well as a sharp decrease in divorce rate.

Graph 8.1 Female activity rate in Europe (%)

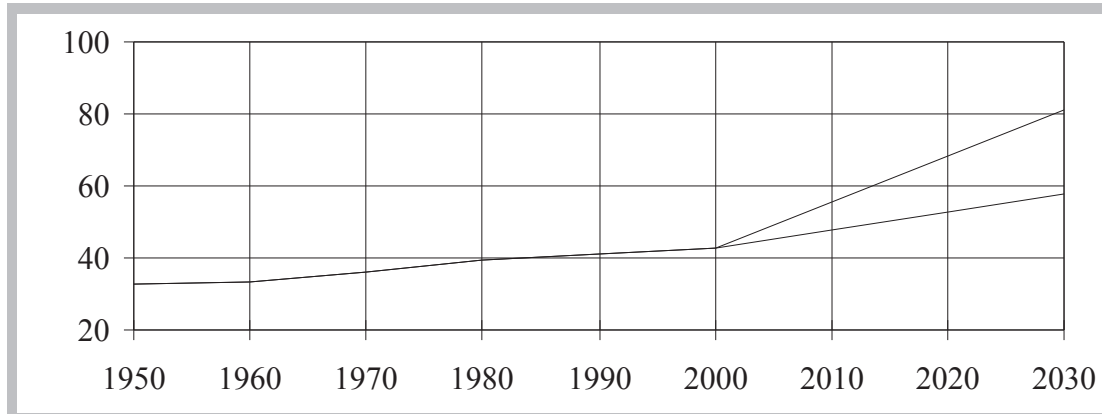

Consensus was almost reached on two issues: the population growth of Europe and its marriage rate. On the first question, panellists agree that they would like European population to grow faster than now, but disagree on the pace of the increase, comprised between 730 and 850 million people. Divorce rate will have to go down sensibly according to our panel and should be comprised between 6 to 18 divorces each year out of 1000 people (Graph. 8.2).

Graph 8.2 Divorce rate in EU-15 and candidate countries

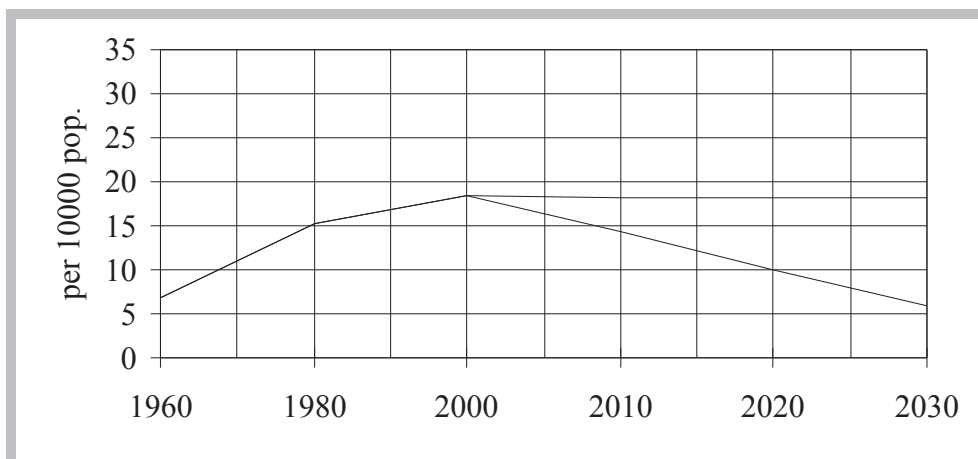

Finally, no consensus was reached over the percentage of people aged 65 and over in the total population; some people wanted that it to increase while others do not.

8.4 Scenarios at 2030

From the analysis of the policy objectives and the key success factors given during the first and the second round, three distinct scenarios for Europe in 2030 have been represented, namely:

- First scenario: *Integrating the elderly, eliminating gender differences*
- Second scenario: *Eliminating social exclusion*
- Third scenario: *Challenges for the future: Active ageing in a women and family-friendly society.*

During the third round, panellists were asked to choose one of the three scenarios. The first one has been selected by 9 out of 14 panellists, and was considered to be *highly desirable* and *possibly feasible*. This scenario, as can be seen from the title, has two main objectives: on the one hand, it seeks to create an age-integrated society by 2030 where elderly people will be able to live independently, reducing their social exclusion. On the other hand, it underlines the importance of gender equality. A third objective is to ensure equal opportunities for children born in low-income families and to reduce the cost of bringing up children.

A preoccupation about elderly people is a prominent feature of the European panel. Low fertility rates in Europe, longer life expectancy both for men and women, and the European-wide type of welfare and pension schemes have been analysed as being contradictory. Therefore, many panellists have argued in favour of a reformed pension scheme, where the transition from working life to retirement would be gradual, flexible, and would come into force at an older age than today. In this way, elderly people would work and be active longer, but the working pattern would be more adapted to their age.

Concretely, experts feel that an age-integrated society should be achieved through individual lifelong development focusing on self-help and independence. The panel showed concern with regard to financial equilibrium linked to the ageing process, and underlines the importance of a just and fair share of the financial burden between the active and inactive populations.

The European experts would also like elderly people to live independently in their own communities as long as possible. A set of specific and tangible measures has been defined such as the construction of elderly friendly homes and apartments, sponsor organisations that deliver meals, drugs and general assistance service, and the ability to offer health aid and housekeeper facilities. More generally, in the future health programmes should be age-specific, while the EU should fund research whose objective is to upgrade healthcare technology and help maintain the independence, privacy and dignity of the elderly. The importance of socialization and interaction of seniors at various levels (local, national and European) was also seen as mean to achieve independence. In other words, interactions should be emphasised not only across generations, but also within an age group. Finally, strong emphasis was put on the risk of social exclusion of the most vulnerable older people, for whom the role of voluntary organisations has been underlined. These associations have to be supported by governments, whose role will be to provide them with economic support, and to fight long-term unemployment.

Panellists agreed on the necessity to promote gender equality, and first of all to tackle the issue of unequal pay for equal work for women and men which is still a widespread feature of the European labour market. The panel emphatically desires a very assertive policy that will monitor and fine organisations showing a gender pay gap, and will also extend controls in the “informal sector” where more women than men are employed in low-paid jobs. In order to break the link between lower remunerations and women employment, occupations where women make up the vast majority should be economically and socially upgraded, while EU media campaigns would seek to counteract gender stereotypes.

Finally, significant agreement was reached about the importance of ensuring equal opportunities for children born in low-income families and of reducing the cost of bringing up children in order to counteract inequality among families and decline in birth rate.

With the help of the SWOT analysis, the panel has formulated some relevant observations. Overall, this scenario is considered to be well-balanced between the various components and useful for the identification of the fundamental issues to be addressed in the near future: the need for integration and independence of the elderly, the same education for all children as a necessary tool in order to achieve equal chances for everyone, and gender equality. To some panellists, this scenario has the merit of promoting the role of the individual, its abilities, initiatives and responsibility while avoiding the risk of excessive state control: “public institutions should serve as *enablers* (i.e. enabling all children to have the same chances in life), but avoiding any additional task, that would be financially unsustainable” said one European expert.

8.5 The Controversial policy issues

In the final section of the Delphi study, panellists had to express their opinions on “controversial issues”: the panel was confronted with opposite options (yes or no) in relation to issues that appear to be quite debated on a European scale. With regard to those controversies upon which consensus¹² was reached after three rounds, the panel had to choose those issues which they wanted to bring in their future. The lists of Controversial Policy Issues-CPIs designed by the research group included 17 items (Table 8.1).

¹² During the first interview panellists are asked to indicate from a CPIs’ list if each of them should or should not stay in place and their positive and negative effect. Between the first and second round the list have been re-formulated according to the type of consensus reached (should or should not) and resubmitted for discussion during the 2nd round. After the 2nd round each one of the CPIs below a predetermined threshold (i.e. CPIs which obtained a low level of consensus among the panellists) have not be resubmitted for discussion during the final round when the panellists are asked to select which CPIs want to be realized by 2030.

Table 8.1 Controversial policy issues according to the reached consensus and frequency of selection in the final scenario

CPIs on which the consensus has been reached		CPIs on which the consensus has not been reached
CPIs	Frequency of selection	
The EU will be based on a European Constitution	12	Harmonization of family policies within the EU (child allowances, parental leave...)
The EU should have its own Foreign Minister who will be spokesperson for a common EU position	9	Introduction of policy measures in the field of population issues (family and fertility, ageing and gender roles) in EU
Enlargement will not be a fundamental and continuous objective of the EU	9	
The EU will have a common policy on immigration and asylum seekers	8	
A European army capable of reacting rapidly in case of emergency will be established	8	
People's rights will be the same	7	
The EU will have a seat at the UN Security Council	7	
Procedures to achieve equal opportunities will be harmonised	5	
English will not be the EU language	5	
Pension rights acquired at national level will be recognised at EU level	4	
Euthanasia will be legalised	3	
Gender quotas within the European Parliament will not be introduced	2	
A harmonised pension system will be introduced	2	
The moratorium on GMOs will be maintained	2	
A common European age limit at retirement will not exist	1	

The panellists have overall indicated that by 2030 they wish - coherently with what has been described so far - to see the European Union proceeding at a faster pace towards greater integration, the attribution of increased competences to EU institutions, and common external policies in the field of defence and security.

With regard to those CPIs which did not obtained a consensus and therefore were not selected in order to be part of future scenarios, it is worthwhile to highlight that these were only pertaining to social policies and more particularly to population and family issues. Different considerations can be made on why consensus was not reached on these questions:

- few panellists declared that there were not advantages of managing those issues at supra-national level. If the principle of subsidiarity applies, then it would be better to manage social and population matters at the national level.

European countries have very different approaches and cultures to family policies and population issues. As a consequence, harmonisation could prove to be problematic.

Our results indicate a positive appreciation in the area of pension rights which in the mind of our panellists should be harmonised at EU level. The harmonisation process promote the recognition of pension rights within all EU countries. However the majority of panellists does not want a common age limit at retirement as different levels of life expectancy and different retirement plans are in place in each country.

Retirement schemes can differ considerably because of historical and social reasons as well as due to different financial realities within each EU member State.

The ban of the GMOs (Genetically Modified Organisms) is one of the controversial policy issues upon which the panel had to declare its point of view. Our results highlight contrary to the current EU policy approving the liberalisation of some GMO products, the panel still believes that the ban on GMOs should be maintained. While a settlement from a legislation point of view has been obtained, the controversy remains in the thinking of our panellists who are opposing the presence within EU countries of GMO products.

Europe in 2030 presents itself with a strong political identity characterised by a European Constitution and same rights for its citizens. EU foreign policy has an assertive edge which is characterised by a common policy on immigration, a European army, a seat at the UN Security Council. Simultaneously, it has emerged that the social and cultural diversity of European population cannot be controlled by the EU: diverse social realities within the 25 EU countries means different tools to manage contrasting realities. Finally, one issue was not controversial at all amongst our panel: English should not become the only EU language to be used within European institutions, and any attempt in this direction will not help the cause of European integration that our panel strongly desires.

9. An European Agenda to 2030

The future of Europe moves from the inadequacy of intervening on emergencies, largely created by our way of constructing societies, to a logic more inspired by a positive and collectively shaping of a social Europe based on the promotion of a good quality of life.

Traditionally we act on emerging problems following a “surviving the tempest approach”, decisions are substantially taken when the boat is sinking versus the understanding of the phenomena that will help us to cruise safely towards sustainable routes.

The problematic approach to social changes is coupled with the excessively simplistic way of looking at them. Society is enacted from different and detached points of view. Each single area is put into frames and rarely bridged with others, in order to create a more systematic and complex and holistic approach. The problematic approach amplifies its negative effect also as a consequence of a short sighted view conducting political thinking and interventions. In fact, our politicians appear to think and act as far as their mandate lasts.

Our understanding of social changes challenges the current mainstreamed approach and wishes to propose an alternative way of enacting society. While in the current society social changes are forced to become problems due to our way of thinking, our approach looks at facts occurring in our society, projects them in the long run and identify collectively positive actions that will sustain their implementation departing from now and moving toward the desired future.

Our approach is therefore based upon five main integrated pillars:

- co-creation: the future designed in our scenario is a project collectively designed by various panellists merging together their diverse perspective;
- long-term: the future scenarios have a 30 years life span enactable from today;
- holistic: future scenarios integrate both the individual and social perspective; policy objectives and associated measures have an economic, cultural, social and psychological perspective; the measures to achieve the policy objectives concerning the three issues are strongly intertwined and often coincide; the future scenarios are described using the voices of a diverse set of thinkers;
- positive: we look at all the positive aspects existing in the present and enact them in the construction of the future;
- realistic: our scenario planning departs from the existing present to describe the future, identifies the weaknesses and threats together with strengths and opportunities to audit feasibility of the scenario.

The policy recommendations resulting from the Delphi study cannot address singularly each one of the three themes - gender roles, ageing, family and fertility - but should alternatively tackle the future with a integrated perspective.

9.1 Shaping a co-created future for Europe up to 2030

The results of our Delphi study indicate a clear route towards which Europe should be built and directed. Europe in 2030 coincides with a better quality of life for its citizens, a simple concept which carries a positive and concrete vision of our future. While it is obvious that political interventions should move towards an improvement of the well-being, in reality this is rarely achieved in an integrated way. The segmented thinking improves one aspect of society and appear to somehow damage many more.

What does quality of life mean in the view of our panellists? It appears that the results of our Delphi coincide with the most widely accepted definition of quality of life, namely is “multi-dimensional welfare term that means good ‘objective’ living conditions and a high degree of ‘subjective’ well-being, and it also includes collective welfare in addition to the individual satisfaction of needs“ (Glatzer¹³, Mohr, 1997, p. 15).

Well-being and collective welfare need to be better defined in terms of the population perceiving and benefiting from them. The results of our study highlight that, while in 2030 there is a collective search for a better quality of life, its achievement calls for different thinking, measures, actions, services depending on the target groups.

Two target groups have emerged from our study, the working age population and those who have never been or are no longer active in the labour market. The classic division between active and non active population has been maintained even though this separation was not adopted as part of our approach.

While for the active population quality of life evolves around the concept of work and family reconciliation, for the elderly and children, who compose the non-active age group, quality of life coincides respectively with better health and guaranteed pensions for the first and child-friendly environment for the latter, which while benefiting children directly, impacts also in an indirect way on the quality of life of families.

In 2030 the active population of Europe aims at achieving - as briefly described above - a higher quality of life in the form of a better work and family reconciliation. Work and family reconciliation means different things depending on the gender trying to achieve it.

In all European countries progress has been made in facilitating the labour force participation of workers with family responsibilities, especially mothers. But it is still women who most often continue to bear the principal burden of family responsibilities. This is due on the one hand to the insufficient account taken by labour market actors, e.g. employers, workers organisations, of the family commitments of the workers and on the other hand to the considerable complexity of reconciling work and family, which still remains insufficiently understood, analysed and properly addressed by specific policies.

Female jobs and career opportunities and their relations with family matters are in fact a complex reality. ‘Internal’ factors depending on the organisation, functioning, and structure of the labour market are part of that reality. These are in turn interdependent upon the ‘external’ factors that pertain to society at large, e.g. existing gender roles inside and outside the family, the changing status of women in education and the labour market, and the political framework for equal opportunities.

The complexity of the issue and all the intertwined relationships have been clearly perceived by the panellists participating to the Delphi survey and in all the

¹³ W. Glatzer, H.S.Mohr (1987), Quality of Life, *Social Indicators Research*, 19, 1, 15-24.

countries the wish to find a better balance between work and family has been strongly expressed. On the agenda of policy makers of today the main aim of national policies should be to enable persons with family and children who are engaged or wish to engage in employment to avoid any conflict between their employment and family responsibilities. The policy actions taken today in this area will possibly make easier the task of reconciling work and family in the future.

The measures suggested by the panellists - as described in the previous chapters of this report - imply a considerable change in attitudes, labour market structures and working patterns in the public and private sectors.

With a view to promote the reconciliation of working and family life, the Delphi study suggests a number of actions which need to be taken in some related priority policy areas, namely:

- the re-organisation of working time;
- the development of adequately financed child-care services;
- the re-organisation of school time and curricula.

Actions to reorganise working time should promote effective flexibility, encouraging employers' to take into account the family responsibilities and the needs of male and female workers. Easier access to part-time work for those workers who so wish/need and easier access, where possible, to options for "distance employment" such as, for example, tele-work or homework for those workers who so wish should also be sustained.

Public and private work environments must become more family-friendly, more aware of the needs of those who want to work and continue to "lead their own life." As long as there is a widespread conviction within the workplace that there must be a hierarchy in the values and behaviour of the employees based on the view that work is more important than any other aspect of peoples' lives, the career and employment opportunities for those who make different choices or who are forced to find a compromise between work commitments and personal life will be necessarily limited.

The need for women and men to meet their responsibilities for child rearing should become a policy priority for 2030. Fathers of newly born children should be allowed a period of leave to be with their families. In addition, both fathers and mothers should have the right to take parental leave but fathers should be encouraged by means of specific actions to enjoy the rights they are entitled to. The need to increase fathers involvement in childcare and family organisation, though expressed by many panellists, is also an issue discarded from the final scenarios. This highlights a hierarchy in priorities positioning the wish to facilitate mothers' participation in the labour market prior to the need to increase fathers' commitment in childrearing.

Economic development in Europe requires a higher participation of women in the labour market. In order to achieve this goal women's role should be re-designed. Various are the priorities shown at national level in order to achieve equal

opportunities and equal treatment between the two genders, such as the reduction of wage differentials between female dominated and male dominated occupations and the reduction of the double burden for women who work and have children. The increasing presence of women in the decision making circles has not been considered a desirable and feasible priority.

By 2030 there will be an expectation in terms of better care services, which should be provided by both the public and private sectors. These services should respond to the increasing needs of parents to reconcile their occupational and family responsibilities. Last but not least, employers should be encouraged to participate, financially and via other means, in the provision of child care for their workers.

An effort should be made to better harmonise school and working hours and to let workers to combine education and work commitments.

Being able to engage individuals with family responsibilities to the labour market can surely play a positive role for our economies, for the promotion of employment, for the strengthening of social cohesion and also in increasing fertility.

The results of our Delphi study are quite clear showing that policy actions in the field of birth's increase should integrate traditional economic measures that support families with children, with innovative ones aimed at realising the increase in births via new work practices.

The measures desired by our panellists to ensure a better reconciliation of job and family responsibilities relate essentially to labour market rules and practices. But the reconciliation of work and family life, promoting as it does self-fulfilment in public, professional, social and family life, is a precondition for a meaningful quality of life.

The future is characterised by an improvement in quality of life of the elderly. To meet this challenge our society should equip itself with policies that reduce the need for long-term care and its consequential costs. Policies designed to respond to elderly needs should be sustained by measures that promote healthy ageing, including its demographic, social and economic effects, and by interventions leading to the postponement in retirement.

Moreover, the Delphi study shows with regard to elderly rights that these can be broken down into three main categories: protection, participation and image. Protection refers to securing the economic, physical and emotional safety of elderly people with regard to their risk of poverty, vulnerability and isolation. In this respect, promoting intergenerational solidarity is a priority for 2030 which may well help in avoiding all the above mentioned risks. Participation refers to the need to establish a greater and more active role of the elderly in society. Image refers to the need to define a more positive, less degrading and discriminatory idea of who elderly persons are and what they are capable of doing.

The achievements of these objectives pursuing a wide-spread improvement in the quality of life of European citizens generate a stronger social cohesion playing the role of a strength key in sustaining the future. Its limits are not in society but in the

decision making process adopted to shape the future. Its limits is the *fear* of policy makers to look beyond their mandate and take the chance to courageously start shaping the future.

Europe in 2030 is a place where everyone no matter their age benefits from a better quality of life sustained by a new welfare system, a reorganisation of work rules and a environment promoting work and family reconciliation. Those who are active in the work-environment will have the chance to choose the time they wish to allocate to their families and to their work, those who are coming close to retirement will slowly exit the labour market if they wish so, and their exit will be shaped in various forms; the youngest will benefit from better services and care supporting their development; the elderly will have better health, will be a more integrated component in society, in constant dialogue with the younger generation. It is not a dream, is a challenge to be considered and enacted.

Annex A: Country scenarios

AUSTRIA

Scenario 1- Economic Model

Desirability level: High

Feasibility level: High

Selected by : 12 panellists

In order to be able to maintain the liquidity of the welfare state system, society must prepare itself for the problems of demographic ageing very soon. To point out these problems, it is necessary to further educate and inform the general public. People must understand that they have to take more responsibility for themselves as well as for others. Policymaking today is criticised as too little innovative and too dogmatic. The trade unions, on the other hand, are expected to show more commitment in gender issues.

Concerning the area of "Ageing", it is the pension system which is given particular relevance. Extending the possibilities of gainful employment in old age is considered the most important measure here.

In the area of "Family and fertility", the main political objective is compatibility of family and career. To achieve this objective, the following measures are seen as particularly necessary: increased availability of child-care facilities in all parts of the country, extension of flexible working times, and the introduction of new models of distributing work.

As for the area of "Gender roles", the objectives most often addressed were "equal opportunities on the job" and "equal opportunities in general". The measures included to paying the same salary for similar work as well as a fairer distribution of paid and unpaid work between men and women. In sum, the scenario can be characterised as follows: to be able to cope with the challenges brought about by the demographic change, it is necessary to achieve a solidarity-based integration of the policies concerned with the pension system, the labour market, gender and family issues.

The "Dream statement list" is quite substantial and heterogeneous. In summary, 13 wishes were given for the subject area of "Ageing", 13 for "Family and fertility", and 15 for "Gender roles". When considering only those wishes that were given four or more times, we have the following picture. In the area of "Ageing", the "generation contract" and the introduction of a basic social security that were considered particularly important. Furthermore the panel stressed the importance of recognizing the multi-cultural nature of future society. In the area of "Family and fertility", the majority of wishes lay with child-care facilities and the introduction of all-

day schooling. In this context, an education system was favoured the basis of which were autonomy, creativity and openness of mind. In the area of “Gender roles”, two wishes received particular emphasis: fair distribution of paid and unpaid work as well as – in close relation to this – a labour market that allows the compatibility of family and career.

B-FLANDERS

Scenario 1: Safe-guarding care and pensions, enabling combination of job and other goals in life

Desirability level: Highly Desirable

Feasibility level: Possibly feasible

Selected by : 9 panellists

In the year 2030, people are assured of a legal pension. As older active people participate more in the labour market, a reduced public debt results in more available means, and pensions are alternatively financed.

Through an improved and income related care insurance, more means for the Time Credit Formula and the social security system for the informal care giver and the elimination of waiting lists, care is safe guarded in our future Flemish Society.

In the year 2030, extended maternity and parental leave are well paid and the number of day care centres has increased and its openings hours prolonged. As a result, the combination of running a family and having a job is going smoothly. Moreover the double burden on mothers is reduced by a family friendly flexibility at the labour market and by the emancipation of men.

Finally, self-fulfilment is encouraged in Flemish society 2030. People can organise their career in a modular way and have flexible working hours a day and a week. Since structural initiatives are taken, such as the introduction of restrictions on reunification of families and measures in the education system, also female migrants now have considerable opportunities to develop themselves.

If we mark the beginning of a period of economic growth, if we face stable international political scene in the 30 years to come, if we face a strong sense of solidarity within the Flemish population, if well-considered policies are pursued in the field of migration, and if policy makers have the nerve to make clear decisions; by the year 2030 this fourth scenario can be realised, and consequently the difficulties that are relate to the themes treated will be dealt with.

Six panellists out of nine situate themselves in the progressive PPA cluster.

This scenario presents an overall scheme to anticipate the matters under investigation: ageing, family and fertility, and gender roles. The issue of ageing is tackled in a twofold manner, with a focus on payable pensions and the care for the elderly. After all the dependency ratio of the old will increase sharply. From 40 older persons against 100 persons in active ages in the year 2000, this ratio is expected to

increase until 63 in the year 2030. Since the pay-as-you-go pension system (Repartitie Systeem) in B-Flanders depends on the active people, the financing of pensions is delicate.

Besides, the population ageing and the decline in family size are forcing the demand for care upwards. The number of 'person-years' in the population, which are lived in illness and dependency will in all probability increase as the 'population at risk' of older and single persons will grow. The total demand for care at home, for adapted housing and for residential and extra-residential health care will increase and even accelerate after 2010.

In the sphere of family and fertility, the scheme introduces measures to combine running a family and having a job: extended and well paid maternity leave and parental leave, an increased number of day care centres, and prolongation of the openings hours of these centres. A better payment for parental leave should facilitate both men and persons in a weak economic position to participate in the scheme.

The same measures are concerned with regard to the gender issue. The emancipation of men is seen as another way to deal with the double burden put on woman. The right to self-fulfilling, another interpretation of the gender issue, gets special attention too, in which the scenario has an eye for migrant women. Finally, to face the current rigid labour market, the scenario introduces some measures referring to career development and flexible labour.

CYPRUS

Scenario 1: Towards an open-minded society

Desirability level: High

Feasibility level: High

Selected by : 8 panellists

Scenario *Towards an open-minded society* is basically family-, economy- and policy oriented. Regarding ageing the policy objectives aim at improving the quality of life of the elderly, e.g. by improving the quality and quantity of health care services. Another policy objective is the promotion of positive policies and of an appropriate climate, which will support the welfare and the general position of the elderly in society by, for example, creating new premises where intergenerational exchanges are facilitated. Another aim is to promote intergenerational solidarity, e.g. by developing new school programs aimed at reducing prejudices towards the elderly.

As regards gender roles, the scenario aims at increasing the presence of women in decision-making roles in governmental, economic, political and social organizations by increasing of the number of women in politics and top managerial positions. Another policy objective is the creation of a society where all citizens, regardless of their sex have an equal right to employment through improving state services for daily

care. In addition, another policy objective is the removal of stereotypes on gender roles through the introduction of school programs for promoting gender equity.

The decrease of the double burden of working mothers is the last policy objective for gender roles through the active promotion by the government of flexible working hours for working parents with young children.

Concerning family and fertility the policy objectives are: the increase of the birth rate (e.g. increase of financial incentives to couples with children), the creation of a society where individuals would have the opportunity of free choice concerning the familial and reproductive field (e.g. improvement of parental leave), improvement of the quality of life of families (e.g. increase of the quantity and quality of the services at a local basis), the development of stable conditions which support the formation and sustenance of a family (e.g. reduction of the unemployment rate amongst young people).

Below are listed panellists dreams about future society

Ageing

Their first wish regards the extension of the age limit for retirement. People can be active in their old age and they should be given the chance to use their skills and experiences. This will give them the opportunity to have a better quality of life and at the same time, to continue their financial contribution to the social insurance fund.

Their second dream is to make use of the skills and experience of the elderly for the benefit of society. They should be regarded and treated as active people, so as to avoid their social exclusion and alienation.

- Better social support of old age, as well as programs to be planned by the state and the municipal authorities, especially for the aged. This will contribute to their independence from their family and to their self-sufficiency
- They also dream of a raise in the pensions, so as to offer the aged a life with more dignity and less dependence on their children

Gender Roles

- Their first dream is the change of mentality towards gender equality or the abolition of gender inequality and proper implementation of the existing legislation
- Their second desire is the education of youth on the issue of gender equality
- Thirdly they would like women themselves to be more confident and more demanding of their rights
- Fourth, they would like women to participate in decision making centers / processes and to occupy managerial positions
- Finally they would like the social upgrading of the role of women-as-mothers

Family and Fertility

- Their first dream is the expansion of the institution of whole-day schooling and of pre-schooling.

- Their second desire is a policy which will aim at the raising of fertility rates
- Their third dream is the reinforcement of the child-care services infrastructure i.e. more state child-care services, and support for the working mother more generally
- They wish for better relationships / communication between couples
- They finally dream for the extension of parental leave for both parents

CZECH REPUBLIC

Scenario 1: Increasing appreciation of all members of society

Desirability level: High

Feasibility level: Possible

Selected by : 9 panellists

It is a relatively widely-defined scenario and it includes a complete range of measures related to all the three areas. About ageing, this scenario focuses on the social status of the elderly and their social inclusion as well as on the basic material conditions of life in old age. It tends to support more traditional views of life in old age as for example the need for increasing and supporting intergenerational solidarity through specific job and school programmes.

This scenario pays great attention to the importance of healthcare once old, through improving the quantity and quality of health care services for the elderly. Concerning gender roles, the scenario highlights the relevance of achieving equality between men and women through removing existing gender stereotypes, increasing the number of women in decision making and facilitating work and family reconciliation.

The latter may be achieved mainly changing the way of working and increasing part-time, tele work, etc.

This scenario emphasizes also the need of redefining individuals' social and family roles irrespective of gender. Great attention should be paid to children and their needs.

ESTONIA

Scenario 1: Sustaining the weakest: children and the elderly

Desirability level: very desirable

Feasibility level: possibly feasible

Selected by : 13 panellists

The scenario is focused on the economic sustainability of the ageing process and the need for a sustainable level of fertility. Sustainable ageing implies: avoiding early retirement, making age at retirement dependent on life expectancy, and making the compulsory second pension “pillar”, of the entire working age population . Active ageing will be also important in 2030 as well as the need to reduce excess male mortality and to prevent chronic diseases. Policy measures aimed at increasing fertility (parental allowances, child allowances and security in living environment) will be realized. Additional measures aimed at facilitating raising children and having a professional careers will be also introduced. Gender roles policies are aimed at facilitating job/family combination: flex-time., conservation of work posts for 3 years after the birth of the child and programmes for return in to workplace after childbirth.

FINLAND

Scenario 1: Combining work and family life

Desirability level: High

Feasibility level: High

Selected by : 8 panellists

The scenario consists of three Policy Objectives, one for each of the suggested themes. The KSFs are focused on changes in the labour market mainly in terms of increasing flexibility in working time schemes according to employees’ family needs. Innovative measures in terms of rebalancing the costs for maternity and parental leaves between female and male dominated economic sectors are proposed.

Equal opportunities should be implemented by increasing sensitivity concerning gendered skills and abilities, and increasing appreciation of skills considered characteristic for women. Furthermore, increasing awareness of existing structural gender discrimination should be achieved through educational campaigns and school programs. Finally, families should be supported in the care of the elderly both with economic measures and leave schemes from work for those who provide care to the old family members. Home care services for the elderly should be developed.

The future society as imagined by the panellists includes: a "renaissance of the family", when the family and work can be combined more flexibly with increasing part-time work and social benefits; an improvement of housing policy to make it easier to form a family; and a change in values so that the family and children would be highly appreciated in the society. In the future, young women would have more often than now a permanent job contract and this would foster family formation and having children. Concerning childcare, at least one of the parents would be able to spend a year at home with the child.

In the future, the ageing of the population would not change the focus of the population policy and the social security system so that it would only benefit retired persons. The society would make better use of the abilities of seniors and people in

Finland would retire at a later age. Seniors would be seen also as consumers and a resource.

GERMANY

Scenario 1: Socio-economic setting “hard facts”

Desirability level: Highly Desirable

Feasibility level: Possibly Feasible

Selected by : 12 panellists

The scenario Socio-economic setting “hard facts” focuses on the social integration of the elderly and the adjustment of the old age dependence ratio as well as on the achievement of work and family reconciliation and to increase the presence of women in key roles positions in the labour market. Overall there is a prevalence of policy objectives in the area of the effects of ageing on society (5 out of 13).

From an ageing perspectives the panel promotes an holistic approach. Ageing society is in fact targeted both from a financial sustainability perspective – adapting the pension system to the ageing society – and in terms of social interventions promoting intergenerational solidarity and the construction of a positive perception of ageing in our society.

Family and fertility have a certain relevance in this scenario, being present with four policy objectives. This section of the scenario strongly focuses on improving the quality of life of families by creating stable conditions, increase the work and family reconciliation and to strength the desire – among younger generation for family creation.

Last but not least, in terms of gender roles, the scenario promotes again a holistic approach that not only wish for a stronger presence of women in the labour market but also invites society to think about work and family reconciliation and reconsidering the inputs that men and fathers should provide to the balanced and happy development of their children and families.

The PPA which has shown the highest frequency associated with scenario 2 is the III one – modern. The “Modern” cluster shows very negative attitudes towards the increase in elderly population but at the same time old people is not considered an obstacle to change. Society should take care of the elderly, possibly extending the number of old people’s homes. The “modern” respondents are in favour of policy measures aimed at supporting parents and facilitating work and family reconciliation.

The dreams associated by the panellists to this scenario are the following:

Ageing

- Higher investments in education
- A better innovative and economic power of Germany

- A dissemination of lifelong learning
- A decrease of unemployment
- An increase of social equity
- A better management of immigration

Family and fertility

- Achievement of work and family reconciliation
- Improvement of childcare facilities
- An increase of the birth rate
- A better quality of the education system
- A better quality and supply of pre-schools and full-time schools
- A stronger focus on population and family policies
- A higher social participation of women
- Improvement of social and intra-familial conditions to increase the birth rate

Gender roles

- An increase of the female employment rate
- Equal opportunities for men and women in the labour market
- Easy re-entry of women in the labour market beyond childbearing
- The improvement of education system
- Equal rights for men and women
- Equal pay for equal work amongst men and women

HUNGARY

Scenario 1: New ways

Desirability level: High

Feasibility level: Possible

Selected by : 5 panellists

By 2030 Hungarian society will rejuvenate through an increase in births. The latter may be achieved via changes in the work schedule. Solidarity between generations will improve through specific initiatives (adopt a grandparent) and job-sharing between young and old workers. The increase in births, which is a specific priority per se, will be achieved via a simplification of international adoption procedures and favouring immigration. Equality of every family form will be a priority for 2030 and the rights of married couples will be extended to all living arrangements. Women will be given more opportunities to work by supporting female entrepreneurial activities and giving incentives to companies employing women.

Panellists dream that having children will no longer lead to poverty, society will give more assistance to young couples, the law will recognize as equal all forms of co-existence. Several institutions will help eliminate violence in the family, ageing people will live at higher standard. There will be more opportunity to support the leisure activities of old people, old people will be more involved in looking after their grandchildren.

Strengths

The scenario concentrates on increasing the number of births, on the expansion of adoption possibilities and on strengthening relations between the generations. This scenario appears realistic; it could help ease the problems concomitant to the population decrease by facilitating immigration.

Weaknesses

The elements relevant to immigrant families. The conflicts of interests in terms of family and genders. Women's part-time employment is not given sufficient emphasis. Under such circumstances the increase of women's employment may lead to the disintegration of the family.

Opportunities

It would be a good thing if the adoption procedure were shortened, the amounts available for the test-tube baby program grew and the institution of surrogate motherhood were widespread. It would also help, if the companies employing women over forty were eligible for tax deduction and if various benefits were available for women entrepreneurs. At 3-4% continuous GDP growth the conditions would be available for the implementation of this scenario.

Threats

Lack of political determination, dilatory, waiting-out tactics. Our economy strongly - in 70-80 per cent - depends on the world economic situation; its weakening performance may erode domestic sources, too.

ITALY

Scenario 1: Population Ageing as a challenge for a better society

Desirability level: High

Feasibility level: High

Selected by : 10 panellists

Only five macro policy objectives characterise this scenario for Italy in 2030, a future in which the issue of the growth of the old population plays a key role. The core of the demographic issue concerning ageing is no longer economic sustainability, but rather the fact of positively considering increased longevity and introducing policies to foster the birth of a population in which the various generations collaborate and benefit from a useful exchange. The result of this approach to the future is positive from the viewpoint of the sustainability of the economic and pension system.

According to the future scenario, in the years up to 2030, Italy will start a process of cultural integration between young people and older people, sustained by continuous and intensive communications and relationships. This process will allow the gradual elimination of those stereotypes which in the past characterised the relationship between the young and older people.

In 2030, the over-65s will be an active segment of the Italian population, no longer excluded and forgotten because of the increasingly fast pace of life in society, but rather utilised due to their experience and resources acquired in a lifetime. In order to attain this dream, initiatives will be promoted to foster the knowledge transfer from older people to young people, exploiting the tendency to maintain traditions, and transfer memories and customs that are still strong especially in a country like Italy. But above all, in this scenario the institutions will support solidarity between the generations through family networks, another typical Italian peculiarity and a potential resource not wholly exploited on the social level.

In 2030, the role of family networks will thus be enhanced by the society as a whole, but above all by the State, through a series of investments and initiatives which over time have highlighted the relevance of the mutual exchange between individuals, households and generations. The Italian grandparents in the new millennium will be happy to “adopt” grandchildren, i.e. to take care of children not belonging to his/her own family nucleus, while the opposite situation will also become widespread i.e. the “adoption” of a grandparent by households other than that of the person needing care and company. In order to achieve this wide-ranging social solidarity, there will be implemented public measures through targeted economic investments, together with significant tax-relief measures in favour of those households where elderly people live permanently or are hosted for some time.

Retirement will lose the rigidity characterising the pension system in the 20th century and the early years of the 21st. In 2030, retirement will be a flexible transition, with gradual and customised timing and methods, with the result of a significant increase in the rate of activity among elderly people.

The opportunities of exchange between generations become concrete in the world of work where job sharing will have become a reality uniting young people and older people. Likewise, as a result of systematic information campaigns to foster and improve the social integration of elderly people, the latter will be increasingly involved

in socially useful jobs. The continuation of paid employment and also volunteer work will be encouraged, in a society increasingly pervaded by a technology, also due to the new opportunities provided by technology finally tailored for elderly people, easier and simpler to use and understand.

Society will become attentive and scrupulous with regard to the living conditions of its population, above all regarding elderly people who live alone. Urban areas will be equipped with an extensive network of services, infrastructures and technologies specifically reserved for elderly people. The Third Sector, in particular the volunteer sector dealing with the care of elderly people, will also undergo a great development due to targeted measures, and numerous “desks” will be opened to foster the supply and demand matching.

Technology will also prove to be an element of fundamental relevance for the improvement of living conditions for the over-65s who live alone, Automation at home will become accessible to all, and technology will become very easy to use. Apartments will be equipped with computerised and integrated systems allowing the monitoring of homes from inside and outside. Cars will also be equipped with technology guaranteeing mobility for all.

In order to encourage socialisation, the State - long committed to the re-qualification of urban park areas - will support the building of new and modern Senior Citizen Communities. The loneliness of elderly people and the problems deriving from living alone will also be faced and solved through the greater collaboration of numerous foreign elderly caregivers, women or men, already working in Italy.

In 2030, according to this scenario, we must not be surprised that the low Italian fertility is no longer considered a critical issue. If, in fact, ageing is considered to be a value to be exploited by society, State measures to foster a recovery of the birth-rate and rebalance the age structure of the population would no longer be a priority. One aspect obviously excludes the other, but perhaps this has never been so clearly indicated in terms of macro policy objectives.

In this future, households and couples will be free to choose their reproductive pattern. The State will not be concerned with increasing or encouraging a recovery of the birth-rate, but it will just acknowledge the current trends and utilise the positive aspect. Therefore, in this scenario there are no policies and actions directly regarding the family and fertility. There are, on the other hand, actions aimed at fostering and supporting the participation of women and in particular of mothers in the labour market. In a certain sense, the panellists assume the right to have a family and children, and policy actions are limited above all to the field of employment.

Within this Italian society in 2030, work by parents is made easier, and in particular the obstacles now preventing women from accessing the labour market will be removed. Co-optation at work will only be a memory; objective methods of evaluation and new criteria of hiring and promotion sensitive to gender differences must be constantly applied. Employers will also formulate strategies to support working women.

Tax-relief measures will be introduced for enterprises which organise continuing training courses for mothers, with a tax relief on social contributions for enterprises that hire mothers. Society itself will favour the work and family reconciliation, above all on the local level. In particular, in order to respond to the needs of households, cities will have more crèche facilities.

Parents will not only be guaranteed simultaneous parental leave, but also equal wages during their voluntary leave. Finally, this Italy in 2030 will encourage and promote associations between parents, and even more importantly will fight against and eliminate the stereotypes regarding the “incapacity” of fathers to manage the care, raising and education of children.

The PPA cluster associated to this scenario designs an Italian society where a young Italian population lives, of which 1/3 are aged between 20 and 29, that intends to have children, and is supported in this expectation by the State through specific measures. This population must enjoy a substantial increase in family allowances, a lowering of taxes for households with children, and a qualitative and quantitative context of crèche facilities for children aged under 3.

There must be an appropriate work and family reconciliation, and greater opportunities for part-time jobs. Incentives for buying/renting homes for households with children and a system of family allowances depending on family income and not on the number of children must be appropriately introduced. Religion must play an important role in the life of young people.

In the dreams of the panellists, “old age will no longer be considered as a phase of mere survival, but a stage of life where we can pay attention to social activity, travel and culture” or also they dream of “a society where there is greater mutual communication between generations and a greater transfer of experience, culture and skills, also through schools”. Panellists also wish that “in time we will be prepared to face the challenges regarding a longer lifespan” also through “a type of welfare focusing on the individuals in their relations with life”.

Among the dreams that the interviewees associate immediately with this scenario is that “the current pension scenario must be revised by the creation of more fluid activities suited to an individual with less physical strength but in any case active”. This is a scenario in which “elderly people produce income but not in competition with young people”. Young and old people are engaged “in the management of innovative projects” thus strengthening the relationships between generations.

Our panellists dream of “a future where families maintain good relationships with elderly people also not necessarily under the same roof” and “elderly people continue to be professionally, intellectually and emotionally related to their family”.

This is a scenario in which “there is great freedom in the choice of family forms which are all socially recognised and accepted”, according to those interviewed. In this depicted scenario, according to the interviewees’ dreams, “female employment must be supported without reducing the birth-rate” The society people dream in 2030

involves a “full sharing of the responsibilities and tasks within the family and in couple relationships” and where men manage to find gratification also in the role of caring for the family”.

LITHUANIA

Scenario 1: Equal Opportunities

Desirability level: High

Feasibility level: Possible

Selected by :11 panellists

The scenario of EQUAL OPPORTUNITIES predominantly echoes the problem of unequal access to educational resources and job opportunities and it includes the issues of inequalities due to gender, class and age. This scenario encompasses three themes: ageing, gender roles, family and fertility.

The red thread through the whole scenario is the achievement of equal opportunities for everybody, regardless age, sex and social class. The scenario stresses the importance of starting from an equalitarian basis and therefore assuring the same opportunities to children of all social classes to access various educational courses and to achieve the type of education they wish. Equal career opportunities should be granted to women, men and older people. The main implementing actors are the State and the private sector, though there is room left for individual freedom and activity.

The scenario EQUAL OPPORTUNITIES aims at eliminating of those structural barriers, which are the main obstacles for some social groups to achieve better quality of life. The obstacles are unemployment, poor living conditions, lack of the pre – school institutions, limited access to the educational sources, and absence of flexible working schemes, lack of the re-training institutions for older people.

This scenario indicates the necessity of using educational tools to strengthen intergenerational solidarity. The PPA scenario associated with Scenario EQUAL OPPORTUNITIES is mainly the so called ‘Conservative-liberal’ one (10 out of 11 panellists). The ‘conservative-liberal’ PPA scenario stresses the personal responsibility of individuals in achieving high quality of life with a moderate state role in caring for older people, obtaining better housing and granting women’s and youth employment. Concerning the dreams expressed by the panellists, they hope for a better development of social services for the older people. The elderly will be given opportunities for life long learning programs and will benefit from the strengthening of intergenerational solidarity. The panellists dream that the state will secure the material quality of life of the older people until the private pension funds begins to function.

In the future, with the help of education, gender stereotyping and gender role imbalances will vanish; we will live in a society where equal rights for all persons will be respected. Women will be not discriminated against; they will be more active in all areas of society and the principle of equal pay for equal work will be introduced and respected.

There will be more stable marriages, but the ones who choose to cohabitate without being married will be also respected. The family will be more democratic and the sharing of parental and spousal responsibilities will be the prevailing social norm. There will be no neglected children and all parents will secure the opportunity to their children to be educated. Youth will choose to stay in Lithuania instead of to emigrate illegally.

THE NETHERLANDS

Scenario 1: Participation/ Emancipation

Desirability level: High

Feasibility level: Possible

Selected by : 13 panellists

In the scenario PARTICIPATION/ EMANCIPATION, ageing is an important issue, and it has three main goals which are all interrelated: to increase the labour-force participation of the elderly measures to be taken concerning schooling and employability; to promote intergenerational solidarity, to remove the age limits for labour force participation of the elderly; and to promote active ageing of the elderly, to increase the participation in courses and the labour force participation and to promote a positive image of the elderly and their contribution to the society.

In this scenario the government thinks that enabling people to combine several goals in life (such as work and children) is an important objective for the next thirty years. Many key success factors for the objective are given, but the three very important ones are more control of employees over working hours, increasing the number of Brede Scholen (combination of school, childcare, childcare facilities for school-going children before and after school and during school holidays, recreation) and to make childcare facilities free of charge. In the participation/emancipation scenario, apart from enabling people to combine work and care, one of the objectives is to promote a more equal division of work and care between men and women.

The scenario also considers the promotion of women in top managerial positions as one of the main objectives for the future. The key success factors comprise amongst others a screening of the selection criteria and procedures for jobs for the presence of prejudices, and removal of these prejudices; and to put an end to the practices of cooptation in case of vacant positions in the board or in managerial posts by determining objective criteria. For the improvement of the situation in politics

the key success factor is to adopt a law which prescribes political parties to state the names of men and women in turns on the list of candidates.

The scenario also focuses on the improvement of the status of foreign women. Many key success factors have been considered very important. Most important however, are firstly information and the obligation to integration (learn language, customs, rules, etc.) and to use integration as a starting point of a change in mentality of men and women; secondly, to act more forcefully in legal matters: a more active role of the authorities; and thirdly society must pay more attention to foreign women and improve their legal position.

It is the so called “moderns” the PPA-cluster more frequently associated with this scenario.

The majority of this group is very tolerant concerning every possible life choice of people (cohabitation, single parenthood, etc.). They think that women can work fulltime; family life will not suffer from that. The group is also positive about childcare: it is good for the education of a child to be cared for partly by others right from childhood. They also think it is fine if the husband cares for the children and the wife has a job, and that women do not necessarily have to be better in caring tasks than men. Their favourite measures facilitating having, looking after, and raising children, are *More and better opportunities for parents with young children to work part-time* and *Better childcare facilities*. Old-age benefits may be financed thorough raising the monthly taxes or social premiums on the income. As a way to fight labour shortage, they have a strong preference (much stronger than the above group) for increasing the labour-force participation of women. Their second choice is to raise the retirement age.

The most important wishes of the panellists are an easy combination between work and family in 2030, which means that child care facilities, including before and after school and during holidays, are sufficient and individual oriented policy-making. Also ranking high on the list is a society that is more flexible, both before age 65 as well as after age 65; and investments in long-life learning. Government and employers should invest in people: life-long learning. It is also very desirable that women take more equal positions in society. Other important wishes are a more equal division of work and care between partners; economic independence of women; and special attention given to low educated women, just to mention some of them.

Furthermore, getting children often coincides with important decisions in a career, and therefore can have direct consequences for someone’s career (especially for women) and earning capacity. That is why, according to the panellists, it is desirable that the relation between having children and one’s earning capacity is less direct.

POLAND

Scenario 1: Improving living conditions and gender equality – state’s support to the families and the elderly

Desirability level: High

Feasibility level: Possible

Selected by :10 panellists

The scenario emphasizes strongly the improvement of living conditions of the Polish families with children and the elderly. However, it is focused not on direct economic support to families but rather on supporting them by improving the institutional framework, through:

- development and improvement of the institutional care of the elderly and children
- improvement of the health care system and better access to it
- development of the services for the elderly
- better and more equal access to education and lower costs of education for families
- improvement of the situation in the labour market – more better paid jobs
- development of the institutional help for the poor and families at risk.

By improving living conditions through developing and improving the institutional framework, the main responsibility is delegated to the state, not to the individual. The state is responsible for arranging provision of care for the elderly and children and supports the families in bringing up the children. Although strengthening social and family networks is also taken into account, but in much lower degree than in two other scenarios.

Gender issues are also comprehensively deeply dealt with in this scenario. In 2030 women will have the same opportunities that men have in the labour market, politics and social life. The scenario strongly highlights the relevance of achieving a fair division of tasks between the partners inside the family as the most important condition for gender equality. The development of flexible working schemes, the availability of childcare facilities and preventing stereotypes on gender roles are relevant targets in the scenario. The scenario pays also attention to the promotion of parenthood. It outlines the need to increase social awareness of the importance and difficulties of being parents and to prevent discrimination against women because of their life choices.

The majority of the panellists associated the selected scenario with the PPA cluster that expresses the highest support for flexible working patterns and equal opportunities for women and men.

The dreams mostly picked out by the panellists who chose scenario 1 are the following. Panellists dream that by 2030 the health care system in Poland will have been improved, old people will have easy access to the health care of a higher quality and old people's homes will be of a higher quality, offering the elderly the possibility of living on their own. In 2030 everyone will be free to choose the preferred living arrangement; if a woman wants to work, she will have the possibility to work, but if she does not she can stay at home without being discriminated due to her choice.

Panellists dream that more women will take top positions, have higher earnings and participate in the social and political life of the country in a higher degree and the family model will be based more on partnership. Finally, citizens will be better informed on methods of birth control, mainly the poorest and low educated ones.

ROMANIA

Scenario 1: Family Friendly

Desirability level: High

Feasibility level: High

Selected by : 6 panellists

The scenario is the most frequently selected by panellists and it is entirely oriented towards family and gender roles. It emphasizes the importance of state support and assistance in both family formation process and eradicating poverty. In fact, improvement in families' living conditions - especially young families - as well as the fight against poverty are the main goals of the scenario.

Economic development is seen as the most important key success factor in attaining all the objectives. The scenario highlights the importance of supporting young generations who wants to have families by offering special employment programs, easy access to loans for building or buying a house with specific state financial support and better childcare facilities. The increase in the number of women who (re)-enter into the labour market after childbearing and childrearing and the development and promotion of balance between work/profession and family life are the main goals in the gender roles domain. In the field of reconciling work and family this scenario favours the improvement of childcare facilities, either provided by the state or by private entrepreneurs, lower taxes for families with children or tax exemption for firms which are hiring women who gave up their jobs to take care of their children and want to work again. This scenario emphasizes social, political and economical problems or realities existing nowadays in Romania.

About future society as dreamt by panellists, although ageing is considered a process with negative implications in the long-term, the respondents have shown real interest in improving elderly conditions. Pension system should be improved to guarantee better life conditions to the elderly. Intergenerational solidarity will become a reality as well as active ageing.

Most of the panellists dream of a society where household tasks are equally shared between partners and there is an equal number of women and men in top career positions. Women will play a more important role in society, will be increasingly present in all domains, and they will be involved in a greater extent in the decision-making process as well and they have well-paid jobs. Panellists dream of a society where education at school will no longer emphasize gender differences and gender roles will be more flexible. Solidarity among women is highly appreciated by our respondents.

Panellists also dreamt about a society where more children are born within married couples and the family roles will be reinforced at the societal level. Finally, the panellists dreamt about a society which can provide the normal living conditions for families with children and increasing living standard for everybody.

SLOVENIA

Scenario 1: Gender/Family

Desirability level: High

Feasibility level: Possible

Selected by :9 panellists

The core of this scenario is the need of more balanced gender roles inside and outside the family. Many KSFs are focused on changes in the labour market both in terms of the rules regulating the participation to work activity of women, mothers and parents in general and of working schemes (part-time, work-at-home, etc.). Greater availability of flexible forms of employment is needed to ease the reconciliation of professional and family life of employed parents.

More understanding by employers is needed, but also a more gender-balanced division of household work and care for children; stereotypes are still widely present. Changes of the labour market should go hand in hand with cultural changes both of fathers and employers. Fathers should be encouraged to take parental leave; employers should be more sensitive to working fathers' involvement in child rearing.

Decision-making regarding having (more) children is related to the general political and economic situation as well as to the economic position of families and child costs.

Five panellists associated the "modern" PPA typology to the GENDER/FAMILY scenario. This cluster is associated with more open up and tolerant attitudes towards new living arrangements. The state plays an important role in the solution of major social and demographic problems (ageing, unemployment, female participation in the labour market, work and family reconciliation, and housing).

This cluster is in favour of all the measures facilitating having, looking after and raising children (particularly improving housing for families with children, substantial decrease in the costs of education of children, allowance at birth of each

child and improved parental leave arrangements for working women who are having a baby).

The panellists dream of a future society where the appropriate share of young people is maintained and the population is reproducing itself. Values like solidarity and mutuality are maintained. Individualism and high value attached to power and youth are not prevailing in the society.

Children are taught about family also in school (for instance: about the importance of family as a basic unit of a society; what being a parent means; what are the partners' roles). There is no violence in families.

The state is engaged in encouraging births and creates conditions for young people to start families (in the areas of employment, housing, highly subsidized childcare).

Gender equality is gaining strength. There is a higher degree of participative democracy in the public sphere. Men and women are equally paid for the same job.

People are aware of the fact that entering into marriage means the continuation of their personal development. There is a high degree of democracy in families. Partners complement each other on an equal basis. There is much more understanding between them, which contributes to the stability of a family. Partners talk more to each other and make agreements (also as regards division of tasks). Men take over more work and responsibility in a family. They take parental and paternity leave more often and for a longer time, and enjoy their employers' understanding.

People prepare themselves for their old age, so that – once old – they are ready for further personal development and able to enjoy a new quality of life. A lot of various activities are organised for the elderly, also in rural areas.

In the dreamed future, the elderly are economically safe. It is their extended families who primarily take care of the elderly and not institutions. Services aimed at easing living conditions of the elderly and ensuring them a quality life are available.

SWITZERLAND

Scenario 1: Human - Work - Security

Desirability level: Very desirable

Feasibility level: Possibly feasible

Selected by: 7 panellists

This medium term scenario includes all themes. It is a Christian-democratic / social-democratic scenario and its basis lay in Bismarck's ideas of welfare: The social security insurance and the reduction of basal risks are in the centre. It focuses on flexi time arrangements and it is pragmatically oriented. The orientation towards families and children is strong. It contains one "utopian" component which includes the

change of the role of men within society. Some policy objectives and KSfs are clearly interconnected. The theme ageing contains two national policy priorities: first the guarantee of the retirement provision and second the flexible transition from working life to retirement. These are strongly linked to each other. The theme family and fertility contains two other national priorities: the compatibility of job and family and child benefit schemes. Finally, the theme gender role is represented by the Po “promotion of the fathers’ responsibilities”.

The scenario is more frequently associated with the PPA-cluster defined as a social democratic group.

The panellists have chosen general dreams that they would like to see realized at 2030. In principle panellists wish that the discussion about demographic aging should be held in a more general way. Finance should not only be talked about, but all aspects of an aging society should be concerned. Early retirement should become a possibility for everybody and no longer an opportunity only offered to rich people. A flexibility of the retirement age should be facilitated.

The intergenerational question and the well-being of children should be put in the centre. The over-taxing of families must be recognized and the solidarity of the young should not be overstrained. A better compatibility of job and family is desired. Gender-equality between men and women will become a reality at 2030 and the different nature of the sexes will be recognized.

Mother- and fatherhood should no longer be seen as a matter of privacy. Inside the family, the division of tasks between men and women will be fair. Women will take over leading positions and pay gap will be eliminated.

Annex B. Themes by countries present in the national questionnaires, in the final scenarios and dropped out during the fieldwork

A	B		C		D	
Themes	Is the theme part of the fieldwork ?		Was the theme dropped along the fieldwork?		Is the theme part of the final scenario?	
	Yes	No	Yes Completely (all POs under this theme were dropped)	Yes Partially (some POs under this theme were dropped some not)	Yes	No
Increase in the number of births	Austria, B-Flanders, Cyprus, Czech Rep., Estonia, Finland, Germany, Hungary, Italy, Lithuania Poland, Romania Slovenia, Switzerland The Netherlands.		B-Flanders, Finland, Lithuania, The Netherlands , Romania, Switzerland.	Austria, Cyprus, Czech Rep., Germany, Italy, Hungary Poland, Slovenia.	Austria, Cyprus, Czech Rep., Estonia, Germany, Hungary, Italy, Poland, Slovenia.	B-Flanders, Finland, Lithuania, The Netherlands , Romania, Switzerland.
Work and family reconciliation	Austria, B-Flanders, Cyprus, Czech Rep., Estonia, Finland, Germany, Hungary, Italy, Lithuania, The Netherlands Poland, Romania Slovenia, Switzerland.		Romania.	Austria, B-Flanders, Czech Rep., Cyprus, Finland, Lithuania, Italy, Slovenia, Hungary, Switzerland.	Austria, B-Flanders, Cyprus, Czech Rep., Estonia, Finland, Germany, Hungary, Italy, Lithuania, The Netherlands, Poland, Slovenia, Switzerland.	Romania.
Changing gender roles	Austria, B-Flanders, Cyprus, Czech Rep., Finland, Germany, Italy, Lithuania Poland, Romania, Slovenia Switzerland. Estonia The Netherlands Hungary		Finland, Lithuania, The Netherlands , Slovenia.	Austria, B-Flanders, Czech Rep., Cyprus, Germany, Estonia, Hungary, Italy, Romania, Switzerland Poland.	Austria, B-Flanders, Cyprus, Czech Rep., Germany, Italy, Lithuania, Poland, Romania Switzerland.	Estonia, Finland, Hungary, The Netherlands , Slovenia.

Active Ageing	Austria, B-Flanders, Cyprus, Czech rep., Estonia, Finland, Germany, Hungary, Italy, Lithuania, The Netherlands, Poland, Romania, Slovenia, Switzerland.		B-Flanders, Cyprus, Germany, Hungary.	Czech Rep., Finland, Italy, Lithuania, Poland, Romania, Slovenia, Switzerland.	Austria, Czech rep., Estonia, Finland, Italy, Lithuania, The Netherlands, Poland, Romania, Slovenia, Switzerland.	B-Flanders, Cyprus, Germany, Hungary.
Child-friendly policies	Czech Rep., Estonia, Finland, Germany, Hungary, Italy, Lithuania, The Netherlands, Poland, Romania, Slovenia, Switzerland.	Austria, B-Flanders, Cyprus.	Finland, Germany, Hungary, The Netherlands, Poland, Romania, Slovenia.	Estonia, Italy, Lithuania, Switzerland.	Czech Rep., Estonia, Italy, Lithuania, Switzerland.	Austria, B-Flanders, Cyprus, Finland, Germany, Hungary, The Netherlands, Poland, Romania, Slovenia.
Sustainability of Pension systems	Austria, B-Flanders, Cyprus, Czech Rep., Estonia, Finland, Germany, Hungary, Italy, Lithuania, The Netherlands, Poland, Romania, Slovenia, Switzerland.			Austria, B-Flanders, Finland, Germany, Hungary, Lithuania, The Netherlands, Poland, Romania, Slovenia, Switzerland.	Austria, B-Flanders, Cyprus, Czech Rep., Estonia, Finland, Germany, Hungary, Italy, Lithuania, The Netherlands, Poland, Romania, Slovenia, Switzerland.	